

Abdeckkappe, Schere, Eckumlenkung...

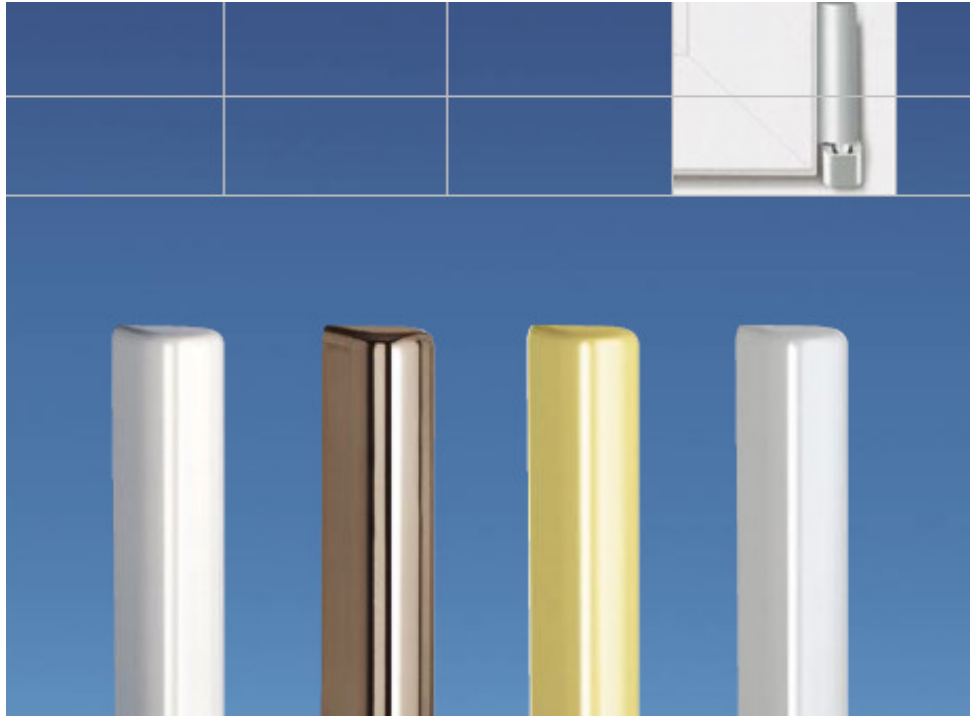

Ausführungen:

- für TITAN AF
- für FAVORIT Si-line

Abdeckkappen W Holz und KF



BEZEICHNUNG	SIEGENIA-AUBI		VPE
ABDECKKAPPE W H			
TITAN			
ABDECKKAPPE W H TITAN GLAENZEND K100	233641	/ 839089	100
ABDECKKAPPE W H TITAN MATT HELL K100	238950	/ 848616	100
ABDECKKAPPE W H TITAN MATT DUNKEL K100	236109	/ 839720	100
WEISS			
ABDECKKAPPE W H RAL9003 K100		FKWB0020-002060	100
BRAUN			
ABDECKKAPPE W H RAL8019 K500	226179	/ 833261	500
SCHWARZ			
ABDECKKAPPE W H RAL9005 SCHWARZ	-	/ 884072	1
SI-SILBER			
ABDECKKAPPE W H SI-SILBER K100		FKWB0020-025060	100
SI-NEUSILBER			
ABDECKKAPPE W H SI-NEUSILBER K500	247099	/ 857168	500
GOLD			
ABDECKKAPPE W H GOLD MATT K100	294512	/ 888353	100
ABDECKKAPPE W H GOLD GLAENZEND K100	233269	/ 838730	100



BEZEICHNUNG	SIEGENIA-AUBI		VPE
ABDECKKAPPE W KF			
TITAN			
ABDECKKAPPE W KF TITAN GLAENZEND K100	234945	/ 842461	100
ABDECKKAPPE W KF TITAN MATT HELL K100	238912	/ 848678	100
ABDECKKAPPE W KF TITAN MATT DUNKEL K100	238974	/ 848692	100
WEISS			
ABDECKKAPPE W KF RAL9003 K100		FKWB0010-002060	100
BRAUN			
ABDECKKAPPE W KF RAL8019 K100		FKWB0010-011060	100
SCHWARZ			
ABDECKKAPPE W KF RAL9005 K100	303658	/ 894125	100
SI-SILBER			
ABDECKKAPPE W KF SI-SILBER K100		FKWB0010-025060	100
SI-NEUSILBER			
ABDECKKAPPE W KF SI-NEUSILBER K500	247419	/ 857595	500
GOLD			
ABDECKKAPPE W KF GOLD MATT K100	238943	/ -	100
ABDECKKAPPE W KF GOLD GLAENZEND K100	234938	/ 842461	100

Abdeckkappen S und S RFA

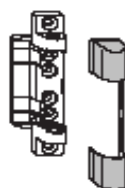
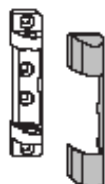

BEZEICHNUNG	SIEGENIA-AUBI		VPE
ABDECKKAPPE S			
TITAN			
ABDECKKAPPE S TITAN GLAENZEND K100	233634	/ 839072	100
ABDECKKAPPE S TITAN MATT HELL K100	238929	/ 848586	100
ABDECKKAPPE S TITAN MATT DUNKEL K100	236093	/ 839713	100
WEISS			
ABDECKKAPPE S RAL9003 K100		FKSL0010-002060	100
BRAUN			
ABDECKKAPPE S RAL8019 K100		FKSL0010-011060	100
SCHWARZ			
ABDECKKAPPE S RAL9005 SCHWARZ K100	303702	/ 884065	100
SI-SILBER			
ABDECKKAPPE S SI-SILBER K100		FKSL0010-025060	100
SI-NEUSILBER			
ABDECKKAPPE S SI-NEUSILBER K500	247082	/ 857151	500
GOLD			
ABDECKKAPPE S GOLD MATT B50/100	294482	/ 888322	100
ABDECKKAPPE S GOLD GLAENZEND K100	233276	/ 838747	100

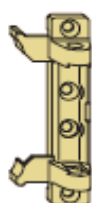

BEZEICHNUNG	SIEGENIA-AUBI		VPE
ABDECKKAPPE S RFA			
TITAN			
ABDECKKAPPE S RFA A0175 TITAN GL. K250	256992	/ 869529	250
ABDECKKAPPE S RFA A0175 TITAN MATT HELL	-	/ 860540	1
ABDECKKAPPE S RFA A0175 TITAN M.DUNKEL	-	/ 868744	1
WEISS			
ABDECKKAPPE S RFA A0175 RAL9003 K100		FKSL0050-002060	100
BRAUN			
ABDECKKAPPE S RFA A0175 RAL8019 K250	249178	/ 860571	250
SCHWARZ			
-	-	/ -	-
SI-SILBER			
ABDECKKAPPE S RFA A0175 SI-SILBER K250	256657	/ 869192	250
SI-NEUSILBER			
ABDECKKAPPE S RFA A0175 SI-NEUSILBER	-	/ 868126	1
GOLD			
ABDECKKAPPE S RFA A0175 GOLD MATT	-	/ 860557	1
ABDECKKAPPE S RFA A0175 GOLD GLAENZEND	-	/ 868522	1

Abdeckkappen S KF S und FEB

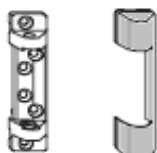

BEZEICHNUNG	SIEGENIA-AUBI		VPE
ABDECKKAPPE S KF-S			
TITAN			
ABDECKKAPPE S KF-S TITAN MATT HELL K100	239018	/ 848708	100
WEISS			
ABDECKKAPPE S KF-S RAL9003 K250	229101	/ 835821	250
BRAUN			
ABDECKKAPPE S KF-S RAL8019 K250	229125	/ 835838	250
SI-SILBER			
ABDECKKAPPE S KF-S SI-SILBER K100	FKSL0020-025060		100
GOLD			
ABDECKKAPPE S KF-S GOLD GLAENZEND K100	234914	/ 842447	100



BEZEICHNUNG	SIEGENIA-AUBI		VPE
ABDECKKAPPE FEB			
TITAN			
ABDECKKAPPE FEB RE TITAN GLAENZEND K100	294093	/ 887059	100
ABDECKKAPPE FEB LI TITAN GLAENZEND K100	294253	/ 887240	100
ABDECKKAPPE FEB RE TITAN MATT HELL K100	294116	/ 887073	100
ABDECKKAPPE FEB LI TITAN MATT HELL K100	294277	/ 887264	100
ABDECKKAPPE FEB RE TITAN M.DUNKEL K100	294109	/ 887066	100
ABDECKKAPPE FEB LI TITAN M.DUNKEL K100	294260	/ 887257	100
WEISS			
ABDECKKAPPE FEB RE RAL9003 K100	FKFE0011-002060		100
ABDECKKAPPE FEB LI RAL9003 K100	FKFE0012-002060		100
BRAUN			
ABDECKKAPPE FEB RE RAL8019 K100	FKFE0011-011060		100
ABDECKKAPPE FEB LI RAL8019 K100	FKFE0012-011060		100
SCHWARZ			
ABDECKKAPPE FEB RE RAL9005 K100	303665	/ -	100
ABDECKKAPPE FEB LI RAL9005 K100	303672	/ -	100
SI-SILBER			
ABDECKKAPPE FEB RE SI-SILBER K500	294086	/ 887042	500
ABDECKKAPPE FEB LI SI-SILBER K500	294246	/ 887233	500
SI-NEUSILBER			
ABDECKKAPPE FEB RE SI-NEUSILBER K500	294123	/ 887080	500
ABDECKKAPPE FEB LI SI-NEUSILBER K500	294284	/ 887271	500
GOLD			
ABDECKKAPPE FEB RE GOLD MATT K100	294147	/ 887103	100
ABDECKKAPPE FEB LI GOLD MATT K100	294307	/ 887295	100
ABDECKKAPPE FEB RE GOLD GLAENZEND K100	294130	/ 887097	100
ABDECKKAPPE FEB LI GOLD GLAENZEND K100	294291	/ 887288	100

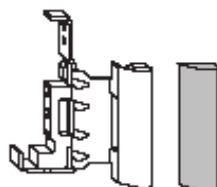
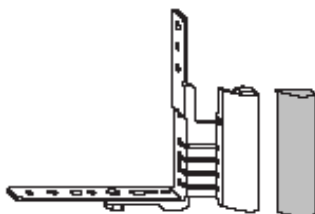

Abdeckkappen EB

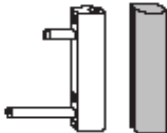

BEZEICHNUNG	SIEGENIA-AUBI		VPE
ABDECKKAPPE EB			
TITAN			
ABDECKKAPPE EB TITAN GLAENZEND K100	294895	/ 887431	100
ABDECKKAPPE EB TITAN MATT HELL K100	294918	/ 887455	100
ABDECKKAPPE EB TITAN MATT DUNKEL K100	294901	/ 887448	100
WEISS			
ABDECKKAPPE EB RAL9003 K100		FKEB0020-002060	100
BRAUN			
ABDECKKAPPE EB RAL8019 BRAUN K500	294963	/ 887547	500
SCHWARZ			
-	-	/ -	-
SI-SILBER			
ABDECKKAPPE EB SI-SILBER K500	294888	/ 887424	500
SI-NEUSILBER			
ABDECKKAPPE EB SI-NEUSILBER	-	887462	1
GOLD			
ABDECKKAPPE EB GOLD MATT K100	294451	/ 887486	100
ABDECKKAPPE EB GOLD GLAENZEND K100	294925	/ 887479	100

Abdeckkappen EL U und EL S U



BEZEICHNUNG	SIEGENIA-AUBI		VPE
ABDECKKAPPE EL			
TITAN			
ABDECKKAPPE EL U TITAN GLAENZEND K100	233627	/ 839065	100
ABDECKKAPPE EL U TITAN MATT HELL K100	238806	/ 848463	100
ABDECKKAPPE EL U TITAN MATT DUNKEL K100	236147	/ 839706	100
WEISS			
ABDECKKAPPE EL U RAL9003 K100		FKEU0010-002060	100
BRAUN			
ABDECKKAPPE EL U RAL8019 K100		FKEU0010-011060	100
SCHWARZ			
ABDECKKAPPE EL U RAL9005 K100	303696	/ 884058	100
SI-SILBER			
ABDECKKAPPE EL U SI-SILBER K500	235751	/ 844342	500
SI-NEUSILBER			
ABDECKKAPPE EL U SI-NEUSILBER K500	247075	/ 857144	500
GOLD			
ABDECKKAPPE EL U GOLD MATT K100	294475	/ 888315	100
ABDECKKAPPE EL U GOLD GLAENZEND K100		FKEU0010-038060	100

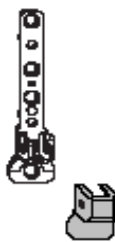

BEZEICHNUNG	SIEGENIA-AUBI		VPE
ABDECKKAPPE EL SU			
TITAN			
ABDECKKAPPE EL-S U TITAN GLAENZEND K100	233665	/ 839102	100
ABDECKKAPPE EL-S U TITAN MATT HELL K100	238837	/ 848494	100
ABDECKKAPPE EL-S U TITAN M.DUNKEL K100	238851	/ 848517	100
WEISS			
ABDECKKAPPE EL-S U RAL9003 K100		FKEL0010-002060	100
BRAUN			
ABDECKKAPPE EL-S U RAL8019 K100		FKEL0010-011060	100
SCHWARZ			
-	-	/ -	-
SI-SILBER			
ABDECKKAPPE EL-S U SI-SILBER K100	256701	/ 869123	100
SI-NEUSILBER			
-	-	/ -	-
GOLD			
ABDECKKAPPE EL-S U GOLD MATT		/ 848500	1
ABDECKKAPPE EL-S U GOLD GLAENZEND K100	233658	/ 839096	100

Abdeckkappen EL O

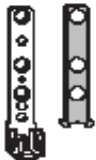

BEZEICHNUNG	SIEGENIA-AUBI		VPE
Abdeckkappe EL O			
TITAN			
ABDECKKAPPE EL O TITAN GLAENZEND K100	233610	/ 839058	100
ABDECKKAPPE EL O TITAN MATT HELL K100	238776	/ 848432	100
ABDECKKAPPE EL O TITAN MATT DUNKEL K100	236130	/ 839690	100
WEISS			
ABDECKKAPPE EL O RAL9003 K100		FKEO0010-002060	100
BRAUN			
ABDECKKAPPE EL O RAL8019 K100		FKEO0010-011060	100
SCHWARZ			
ABDECKKAPPE EL O RAL9005 K100	303689	/ 838884	100
SI-SILBER			
ABDECKKAPPE EL O SI-SILBER K500	235744	/ 844335	500
SI-NEUSILBER			
ABDECKKAPPE EL O SI-NEUSILBER K500	251195	/ 863251	500
GOLD			
ABDECKKAPPE EL O GOLD MATT K100	294468	/ 888308	100
ABDECKKAPPE EL O GOLD GLAENZEND K100	233306	/ 838778	100

Abdeckkappen W RB

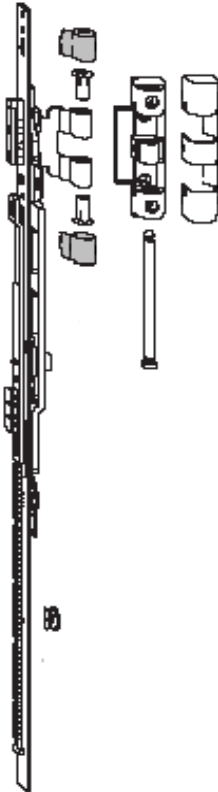

BEZEICHNUNG	SIEGENIA-AUBI		VPE
ABDECKKAPPE W RB			
TITAN			
ABDECKKAPPE W RB RE TITAN GLAENZEND K100	233696	/ 233696	100
ABDECKKAPPE W RB LI TITAN GLAENZEND K100	233719	/ 839188	100
ABDECKKAPPE W RB RE TITAN MATT HELL K100	FKWB0041-034060		100
ABDECKKAPPE W RB LI TITAN MATT HELL K100	FKWB0042-034060		100
ABDECKKAPPE W RB RE TITAN MATT DUNKEL		/ 850329	1
ABDECKKAPPE W RB LI TITAN MATT DUNKEL		/ 850350	1
WEISS			
ABDECKKAPPE W RB RE RAL9003 B50/500	230152	/	500
ABDECKKAPPE W RB LI RAL9003 B50/500	230176	/	500
BRAUN			
ABDECKKAPPE W RB RE RAL8019 B50/500	230169	/ 837771	500
ABDECKKAPPE W RB LI RAL8019 B50/500	230183	/ 837795	500
SCHWARZ			
ABDECKKAPPE W RB RE RAL9005 SCHWARZ	202.5249.6001S20		1
SI-SILBER			
ABDECKKAPPE W RB RE SI-SILBER K100	240786	/	100
ABDECKKAPPE W RB LI SI-SILBER K100	240847	/	100
SI-NEUSILBER			
ABDECKKAPPE W RB RE SI-NEUSILBER K100	247167	/	100
ABDECKKAPPE W RB LI SI-NEUSILBER K100	247174	/ 857229	100
GOLD			
ABDECKKAPPE W RB RE GOLD MATT		/ 891384	1
ABDECKKAPPE W RB LI GOLD MATT		/ 850374	1
ABDECKKAPPE W RB RE GOLD GLAENZEND K100	233702	/ 839171	100
ABDECKKAPPE W RB LI GOLD GLAENZEND K100	233726	/ 839195	100

Abdeckkappen S 7 RB

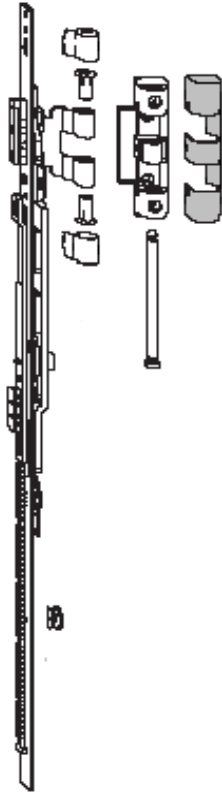

BEZEICHNUNG	SIEGENIA-AUBI	VPE
Abdeckkappe S 7 RB		
TITAN		
ABDECKKAPPE S 7 RB TITAN GLAENZEND K100	233672 / 839140	100
ABDECKKAPPE S 7 RB TITAN MATT HELL	/ 850305	1
ABDECKKAPPE S 7 RB TITAN MATT DUNKEL	/ 850299	1
WEISS		
ABDECKKAPPE S 7 RB RAL9003 B50/250	230138 / 837740	250
BRAUN		
ABDECKKAPPE S 7 RB RAL8019 B50/250	230145 / 837757	250
SCHWARZ		
-	- / -	-
SI-NEUSILBER		
ABDECKKAPPE S 7 RB SI-SILBER K100	240700 / 850565	100
SI-NEUSILBER		
ABDECKKAPPE S 7 RB SI-NEUSILBER K100	247150 / 857205	100
GOLD		
ABDECKKAPPE S 7 RB GOLD MATT	/ 850312	1
ABDECKKAPPE S 7 RB GOLD GLAENZEND K100	233689 / 839157	100

Scheren, Zusatzschere

BEZEICHNUNG	SIEGENIA-AUBI		VPE
SCHERE F2			
SCHERE F2 GR.0 TS K25	FFB 230 - 430 mm	FSKK1100-100040	25
- Mit UMLENKUNG VS SCHMAL	FFB 230 - 344 mm	FEUL0260-100041	25
- Mit UMLENKUNG VS	FFB 345 - 430 mm	FEUL0250-100042	25

SCHERE F2 GR.1 TS K25	FFB 431 - 680mm	FSKK1010-100040	25
SCHERE F2 GR.2 1RS TS K25	FFB 681 - 850 mm	FSKK1120-100040	25
SCHERE F2 GR.3 1RS TS K25	FFB 851 - 1050 mm	FSKK1030-100040	25
SCHERE F2 GR.4 1RS TS K25	FFB 1051 - 1250 mm	FSKK1040-100040	25

mit KRT Zusatzschere F2	FFB 1251 - 1560 mm	FMZS0040-100040	25
-------------------------	--------------------	-----------------	----

SCHERE F2 GR.3 1RS TS K25	FFB 1251 - 1450 mm	FSKK1030-100040	25
SCHERE F2 GR.4 1RS TS K25	FFB 1451 - 1560 mm	FSKK1040-100040	25



BEZEICHNUNG	SIEGENIA-AUBI		VPE
KARTON ZUSATZSCHERE F2			
KARTON ZUSATZSCHERE F2 TS	FFB 1251 - 1450 mm	FMZS0040-100040	25
Inhalt:			
- ZWISCHENSTUECK ZUSATZSCHERE 1RS TS		FZOK0020-100010	
- ZUSATZSCHERE TS		/ 704035	
- KLEMMFEDER Z		202.5346.5001.A1	



Schere TBT

BEZEICHNUNG	SIEGENIA-AUBI		VPE
Schere 7 Z			
SCHERE 7/Z RE TS K10	FFB 580 - 830 mm	FSSK0011-100020	10
SCHERE 7/Z LI TS K10	FFB 580 - 830 mm	FSSK0012-100020	10



BEZEICHNUNG	SIEGENIA-AUBI		VPE
Schere TBT			
Benötigte Komponenten: Scherenstulp F2 und Scherenarm TBT			
SCHERENSTULP F2			
SCHERENSTULP F2 GR.1 TS K25		FSSK0010-100040	25
FFB 431 - 680 mm			
SCHERENSTULP F2 GR.2 1RS TS K25		FSSK0120-100040	25
FFB 681 - 850 mm			
SCHERENSTULP F2 GR.2 TS K25		FSSK0020-100040	25
FFB 681 - 850 mm			
SCHERENSTULP F2 GR.3 1RS TS K25		FSSK0030-100040	25
FFB 851 - 1050 mm			
SCHERENSTULP F2 GR.4 1RS TS K25		FSSK0040-100040	25
FFB 1051 - 1250 mm			

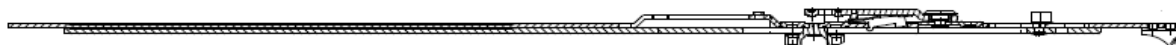

BEZEICHNUNG	SIEGENIA-AUBI		VPE
SCHERENARM TBT			
SCHERENARM TBT GR.1 TS K25		TSAT0010-100040	25
FFB 431 - 680 mm			
SCHERENARM TBT GR.2 TS K25		TSAT0020-100040	25
FFB 681 - 850mm			
SCHERENARM TBT GR.3 TS K25		TSAT0030-100040	25
FFB 851 - 1560			



Zusatzschere

BEZEICHNUNG	SIEGENIA-AUBI	VPE
KARTON ZUSATZSCHERE F2 RB RS TS K25	FMZS0100-100040	25
Inhalt:		
- ZUSATZSCHERE VS-RB A0760 TS		
- ZWISCHENSTUECK ZS RB 1RS TS	FZVK0010-100010	

Zusatzschere

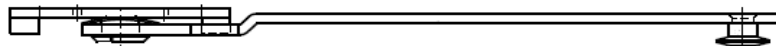

Zwischenstück

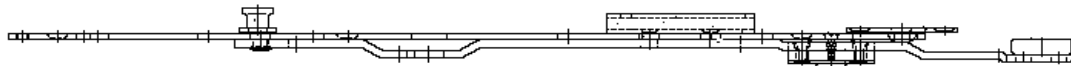

Scherenstulp. Scherenarm

BEZEICHNUNG	SIEGENIA-AUBI	VPE
SCHERENSTULP DF/ON TS K100	FFB 431-1560 mm	TSSD0030-100060 100

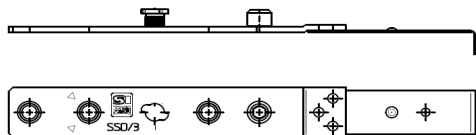

BEZEICHNUNG	SIEGENIA-AUBI	VPE
SCHERENARM DF TS K100	FFB 431-1560 mm	TSAD0010-100061 100

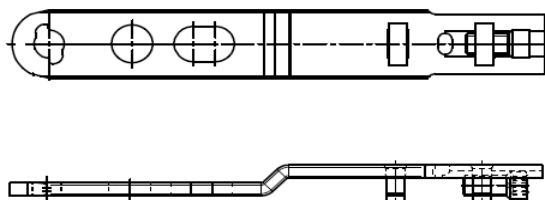

BEZEICHNUNG	SIEGENIA-AUBI	VPE
SCHERENSTULP DF/MN TS K100	FFB 431-1560 mm	TSSD0020-100060 100

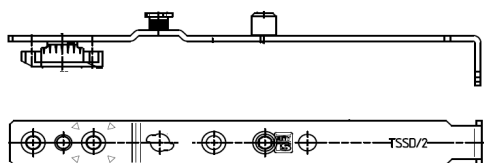

Eckumlenkungen

BEZEICHNUNG	SIEGENIA-AUBI	VPE
UMLENKUNG ES040/STULP 1RS TS K25	FMEU0050-100040	25

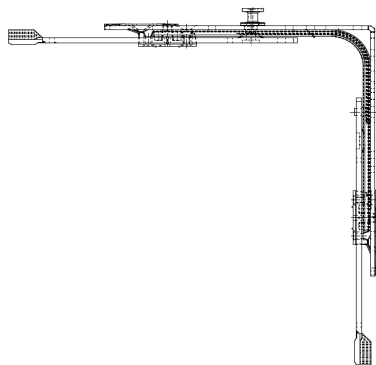

BEZEICHNUNG	SIEGENIA-AUBI	VPE
UMLENKUNG VSO SP 1RS TS K25	FEUL0300-100040	25

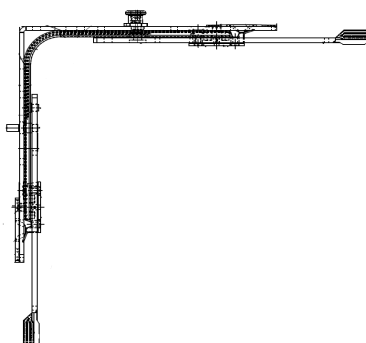

BEZEICHNUNG	SIEGENIA-AUBI	VPE
UMLENKUNG VS 1RS KLEMMBAR TS K25	FEUL0250-100041	25

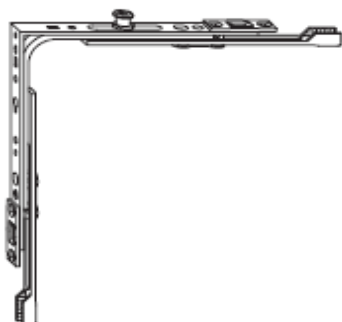

Eckumlenkungen

BEZEICHNUNG	SIEGENIA-AUBI	VPE
UMLENKUNG VS A0055 2RS TS K25	FEUL0270-100040	25

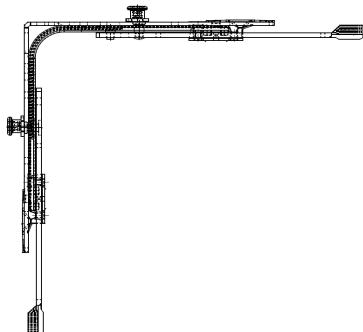

BEZEICHNUNG	SIEGENIA-AUBI	VPE
ECKUMLENKUNG VSO A0089 SCHMAL TS K25		
schmal, 2 Flg.	278666 / 702932	25



BEZEICHNUNG	SIEGENIA-AUBI	VPE
UMLENKUNG VS SCHMAL 1RS TS K25	FEUL0260-100040	25

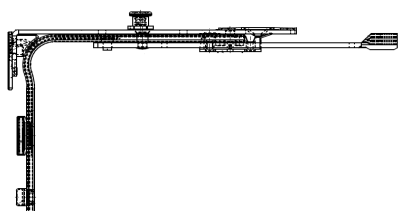

BEZEICHNUNG	SIEGENIA-AUBI	VPE
ECKUMLENKUNG VSO-DS 1RS TS K25	FEUL0470-100040	25

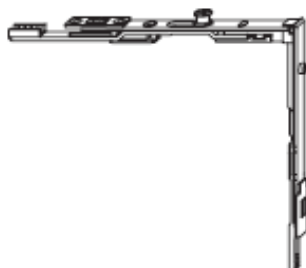

Eckumlenkungen

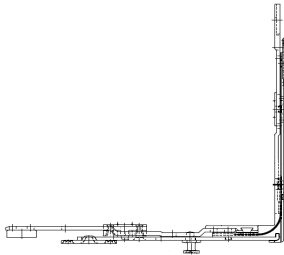

BEZEICHNUNG	SIEGENIA-AUBI		VPE
ECKUMLENKUNG VS-DS S-ES A0149 TS K25			
Für FFB <302 mm	278765	/ 703021	25

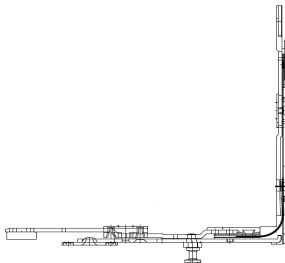

BEZEICHNUNG	SIEGENIA-AUBI		VPE
UMLENKUNG A0273			
UMLENKUNG F2 VSU DS 1S A0273 TS K25	FEUL1240-100040		25
140mm x 140 mm			
Zahnung: Favorit			
In Kombination mit KRL SL-S FRKU....			

BEZEICHNUNG	SIEGENIA-AUBI		VPE
UMLENKUNG AF VSU/K+ DS 1S TS K25			
140mm x 210 mm	TEUL1230-100040		25

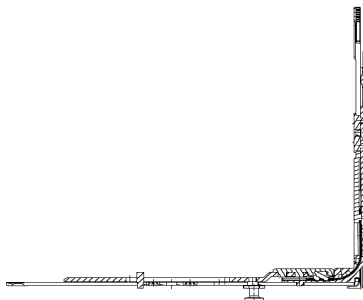

Eckumlenkungen

BEZEICHNUNG	SIEGENIA-AUBI	VPE
UMLENKUNG VSO STULP WK2 1RS TS K25	FEUL0410-100040	25

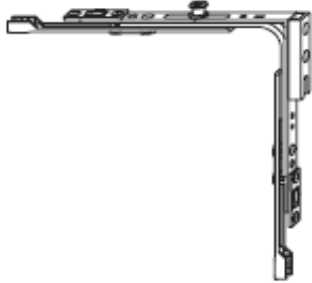

BEZEICHNUNG	SIEGENIA-AUBI	VPE
ECKUMLENKUNG VSU RS STULP WK2 TS K25	FMEU1000-100040	25



BEZEICHNUNG	SIEGENIA-AUBI	VPE
UMLENKUNG F2 VSU/K+ STULP WK2 1S TS K25	FMEU1010-100040	25

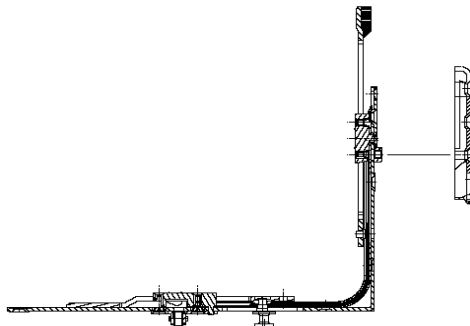

BEZEICHNUNG	SIEGENIA-AUBI	VPE
Eckumlenkung VS S-ES		
A0102 TS	FEUL0100-100040	25



Eckumlenkungen

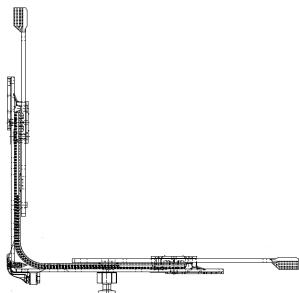

BEZEICHNUNG	SIEGENIA-AUBI		VPE
ECKUMLENKUNG A0273			
ECKUMLENKUNG VSU S-ES FH/13 A0273 TS K25	FEUL1230-100040		25
140mm x 140 mm			
Zahnung: Favorit			

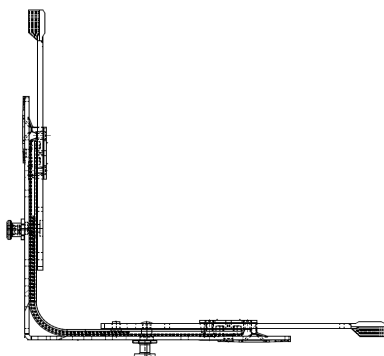

BEZEICHNUNG	SIEGENIA-AUBI		VPE
UMLENKUNG VSU A0055 1S 1RS TS K25			
	FEUL1150-100040		25

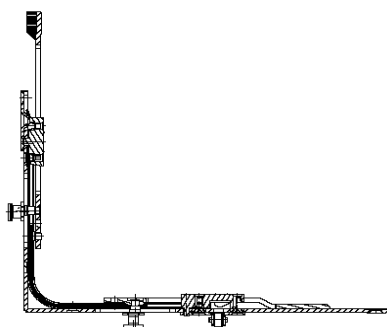

BEZEICHNUNG	SIEGENIA-AUBI		VPE
UML. F2 VSU/K+ A0055 FH 1S 1RS TS K25			
mit montierten FH, für 9 und 13 mm NL verwendbar	FEUL1210-100040		25

Eckumlenkungen



BEZEICHNUNG	SIEGENIA-AUBI			VPE
Eckumlenkung VSU S-ES FH/9				
mit Flügelheber, Nutachse 9 mm	FEUL1070-100040			25
STATUS AUSLAUF				
Nachfolger:	FEUL1200-100040			

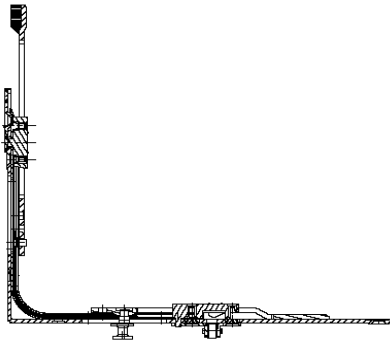

BEZEICHNUNG	SIEGENIA-AUBI			VPE
UMLenkung F2 VSU/K+ FH 1S TS K25				
mit montierten FH, für 9 und 13 mm NL verwendbar	FEUL1200-100040			25

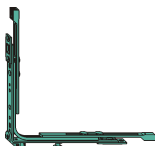

BEZEICHNUNG	SIEGENIA-AUBI			VPE
Eckumlenkung VSU S-ES FH/13				
mit Flügelheber, Nutachse 13 mm	FEUL1080-100040			25



BEZEICHNUNG	SIEGENIA-AUBI			VPE
Eckumlenkung VSO/SF S-ES				
für Schrägfenster	FEUL0130-100040			25

Eckumlenkungen

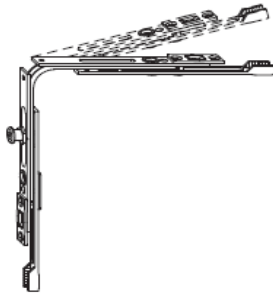

BEZEICHNUNG	SIEGENIA-AUBI	VPE
UMLENKUNG VSO SF 1RS TS K25	FEUL0280-100040	25

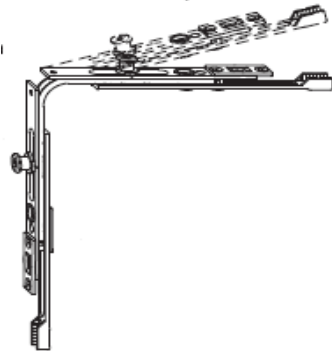

BEZEICHNUNG	SIEGENIA-AUBI	VPE
UMLENKUNG VSO SF A0055 2RS TS K25	FEUL0400-100040	25

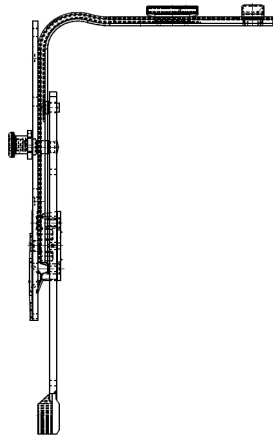

BEZEICHNUNG	SIEGENIA-AUBI	VPE
UMLENKUNG VSO SF SCHMAL 1RS TS K25	FEUL0290-100040	25

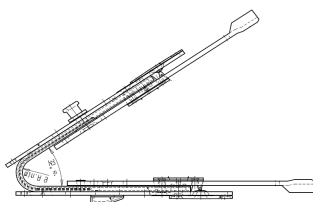

BEZEICHNUNG	SIEGENIA-AUBI	VPE
UMLENKUNG VSU-DEF 1RS TS K10	FEUL1180-100020	10

Eckumlenkungen

BEZEICHNUNG	SIEGENIA-AUBI	VPE
UMLENKUNG RB 1RS STULPF/STICHB TS K25	FEUL0420-100040	25
Stulpflügel		
Stichbogen		

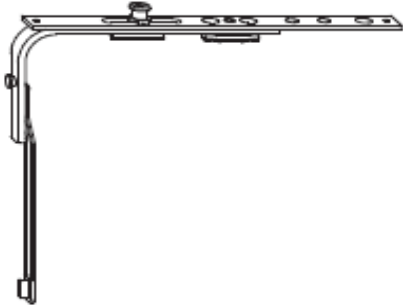

BEZEICHNUNG	SIEGENIA-AUBI	VPE
UMLENKUNG VSU RB 1S 1RS TS K25	FEUL1160-100040	25

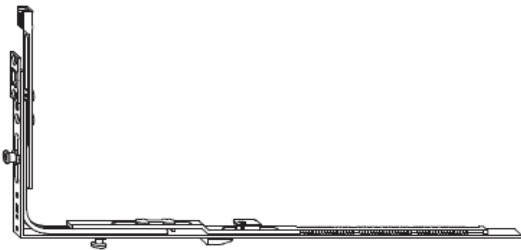

BEZEICHNUNG	SIEGENIA-AUBI	VPE
Eckumlenkung BSU H-18-20		
ohne MV	278857 / 703106	25

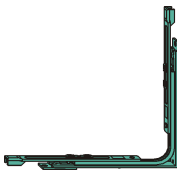

BEZEICHNUNG	SIEGENIA-AUBI	VPE
Füllstulp		
für Eckumlenkung VSO und VSU	305324 / 718230	250



Eckumlenkungen BSU S-ES Holz und Kunststoff

BEZEICHNUNG	SIEGENIA-AUBI	VPE
H-4/15-9 GBA TS		
ECKUML.BSU S-ES LI H-4/15-9 GBA TS	FEUL3052-100040	25
ECKUML.BSU S-ES RE H-4/15-9 GBA TS	FEUL3051-100040	25
H 18-9 TS		
ECKUMLINKUNG BSU S-ES LI H 18-9 TS	FEUL3022-100040	25
ECKUMLINKUNG BSU S-ES RE H 18-9 TS	FEUL3021-100040	25
H 18-13 TS		
ECKUMLINKUNG BSU S-ES LI H 18-13 TS	FEUL3062-100040	25
ECKUMLINKUNG BSU S-ES RE H 18-13 TS	FEUL3061-100040	25
H 20-9 TS		
ECKUMLINKUNG BSU S-ES LI H 20-9 TS	FEUL3042-100040	25
ECKUMLINKUNG BSU S-ES RE H 20-9 TS	FEUL3041-100040	25
H 20-13 TS		
ECKUML.BSU S-ES H 20-13 LI.TS	FEUL3012-100040	25
ECKUML.BSU S-ES H 20-13 RE.TS	FEUL3011-100041	25

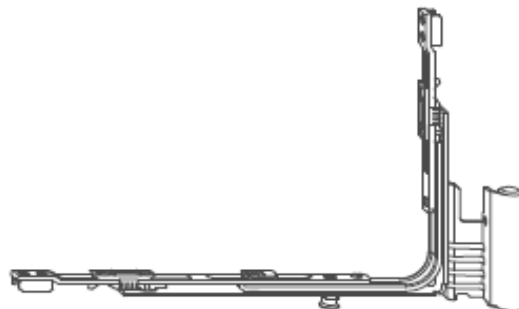

BEZEICHNUNG	SIEGENIA-AUBI	VPE
KF-12/20-9 TS		
ECKUML.BSU S-ES KF-12/20-9 RE TS K25	289594 / 710388	25
ECKUML.BSU S-ES KF-12/20-9 LI TS K25	289617 / 710494	25
KF-12/20-13 TS		
ECKUML.BSU S-ES KF-12/20-13 RE TS K25	FEUL3081-100040	25
ECKUML.BSU S-ES KF-12/20-13 LI TS K25	FEUL3082-100040	25



Eckumlenkungen



BEZEICHNUNG	SIEGENIA-AUBI	VPE
UMLENKUNG BS/K3 GR.1+ 2RS TS K25	TEUL2380-100041	25
2 S-RS Zapfen		

UMLENKUNG BS/K3 GR.2+ 2RS TS K25	TEUL2390-100042	25
2 S-RS Zapfen		

BEZEICHNUNG	SIEGENIA-AUBI	VPE
AUSHEBELSICHERUNG 9 MM A0089 TS K25	TFAH0060-100040	25
NL 9mm		
AUSHEBELSICHERUNG 9 MM TS K25	TFAH0010-100040	25
NL 13 mm		

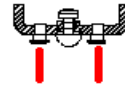

BEZEICHNUNG	SIEGENIA-AUBI	VPE
UMLENKUNG BSO/K3+ 1RS TS K25	TEUL2400-100040	25
1 S-RS Zapfen		

BEZEICHNUNG	SIEGENIA-AUBI	VPE
UMLENKUNG BS/K3 GR.1+ 1RS TS K25	TEUL2410-100041	25
1 S-RS Zapfen		



BEZEICHNUNG	SIEGENIA-AUBI	VPE
UMLENKUNG BS/K3 GR.2+ 1RS TS K25	TEUL2420-100042	25
1 S-RS Zapfen		

Eckumlenkungen

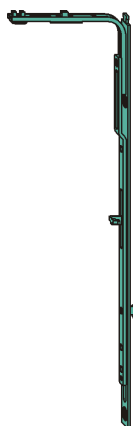

BEZEICHNUNG	SIEGENIA-AUBI		VPE
Eckumlenkung VSU/BS			
Gr. 50, 800-1200 mm	278147	/ 702550	25
Gr. 70, 1000-1400 mm	278161	/ 702567	25
Gr. 90, 1400-1560 mm	278185	/ 702574	25
Gr. 130, 1800-2360 mm	278789	/ 703045	25

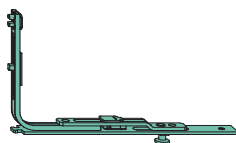

BEZEICHNUNG	SIEGENIA-AUBI		VPE
Eckumlenkung BS S-ES			
Gr. 20, 480-600 mm	278918	/ 703168	25

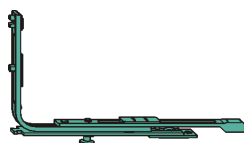

BEZEICHNUNG	SIEGENIA-AUBI		VPE
Eckumlenkung			
Eckumlenkung VSU S-ES	278543	/ 702857	25

Schliesser



BEZEICHNUNG	SIEGENIA-AUBI	VPE
SCHLIESSER VSO 90 GRAD 1RS TS K50	FESC0050-100050	50



BEZEICHNUNG	SIEGENIA-AUBI	VPE
KIPPRIEGELBAUTEIL TS K25		
180°	276372 / 701072	25



BEZEICHNUNG	SIEGENIA-AUBI	VPE
SCHLIESSER TS K50		
90°	279014 / 703243	50



BEZEICHNUNG	SIEGENIA-AUBI	VPE
SCHLIESSER GEGENLAUEFIG TS K50		
90°	279038 / 703250	50



BEZEICHNUNG	SIEGENIA-AUBI	VPE
SCHLIESSER S-ES 180GRAD TS K25		
180°	295816 / 713624	25



BEZEICHNUNG	SIEGENIA-AUBI	VPE
SCHLIESSER S-ES 90GRAD TS K25		
90°	295830 / 713631	25



BEZEICHNUNG	SIEGENIA-AUBI	VPE
SCHLIESSER S-ES 180GRAD WEITERK.TS K50		
180°	302408 / 717448	50