

Getriebschloss AS7170

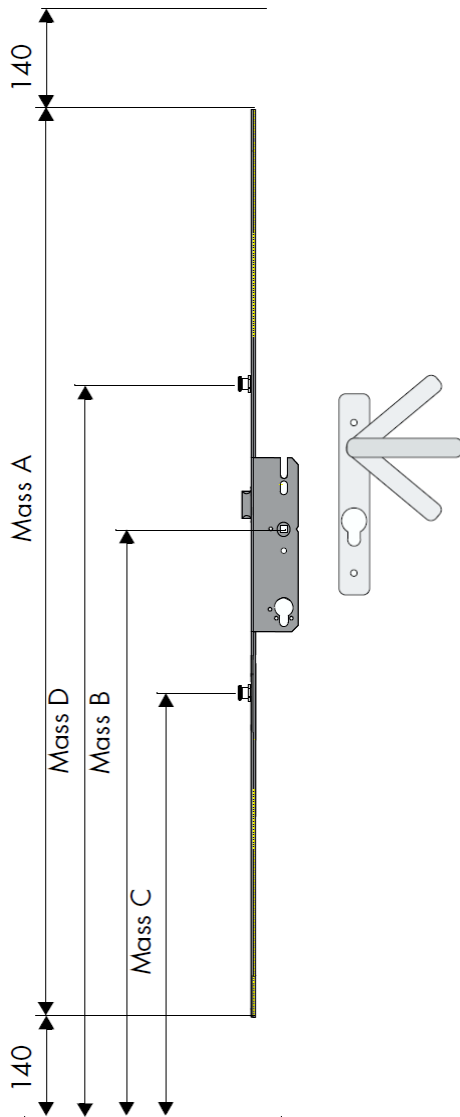

Ausführungen:

- Für TITAN AF
- Für FAVORIT Si-line

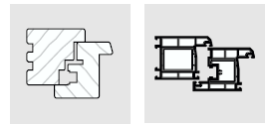

- Getriebschloss AS 7170**
- Stulpbreite 16 mm
 - Kastendicke 16 mm
 - Für Rund- und Profilzylinder
 - Komfortpilzbolzen
 - Dornmasse 30 – 55 mm
 - Anschlussbauteile oben und unten können vom Produktprogramm TITAN AF eingesetzt werden.
 - Hebeleinstellungen:
 Waagrecht = Normal
 -40° = Entriegelung der Rollzapfen
 +40° = Verriegelung der Rollzapfen

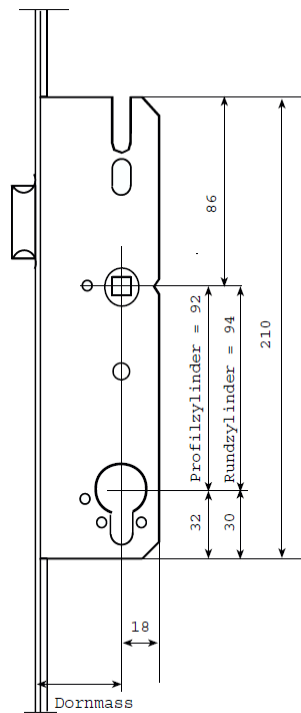

Bezeichnung	Dornmasse	FFH (mm)	Mass (mm)					Artikelnummer
			G	A	B	C	D	
Getriebschloss Rundzylinder	30 mm	1800 -2000	990	1720	990	666	1266	3476019
Getriebschloss Rundzylinder	35 mm	1800 -2000	990	1720	990	666	1266	3476020
Getriebschloss Rundzylinder	40 mm	1800 -2000	990	1720	990	666	1266	3476016
Getriebschloss Rundzylinder	45 mm	1800 -2000	990	1720	990	666	1266	3476021
Getriebschloss Rundzylinder	50 mm	1800 -2000	990	1720	990	666	1266	3476018
Getriebschloss Rundzylinder	55 mm	1800 -2000	990	1720	990	666	1266	3476022
Getriebschloss Profilzylinder	35 mm	1800 -2000	990	1720	990	666	1266	3476023
Getriebschloss Profilzylinder	40 mm	1800 -2000	990	1720	990	666	1266	3476024
Getriebschloss Profilzylinder	45 mm	1800 -2000	990	1720	990	666	1266	3476025
Getriebschloss Profilzylinder	50 mm	1800 -2000	990	1720	990	666	1266	3476026
Getriebschloss Profilzylinder	55 mm	1800 -2000	990	1720	990	666	1266	3476027

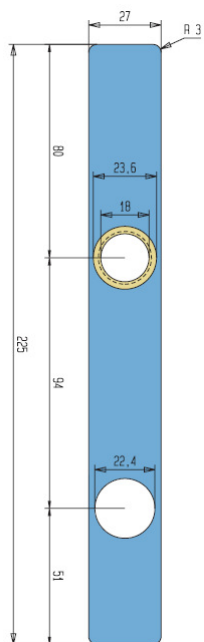
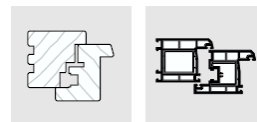

1) Langschild aussen - Rundzylinder

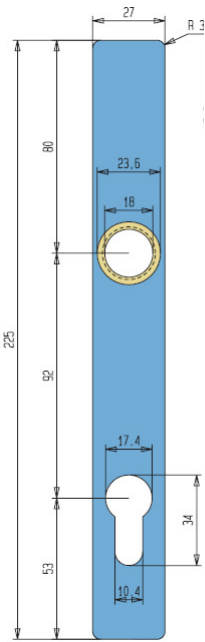

2) Langschild aussen - Profilzylinder

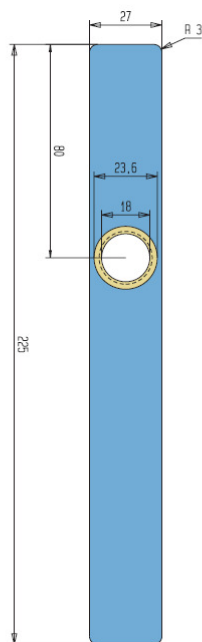

3) Langschild aussen - blind

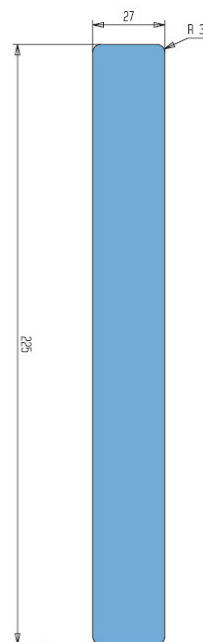

4) Langschild aussen - ganz blind

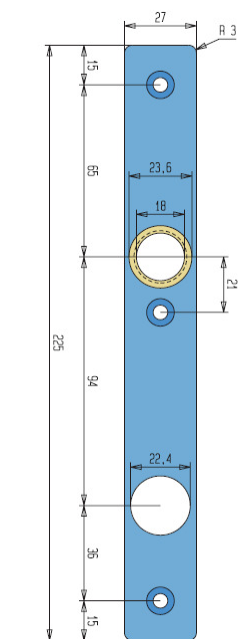
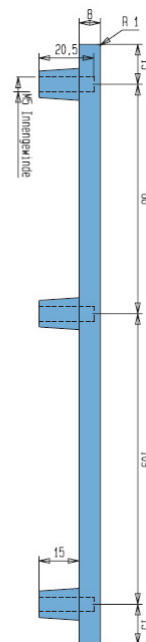

5) Langschild innen - Rundzylinder

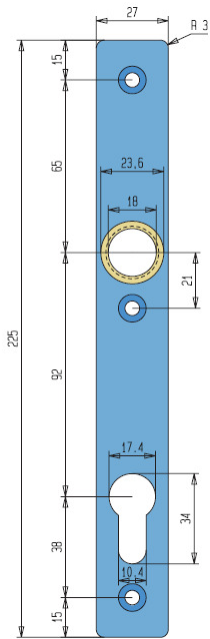

6) Langschild innen - Profilzylinder

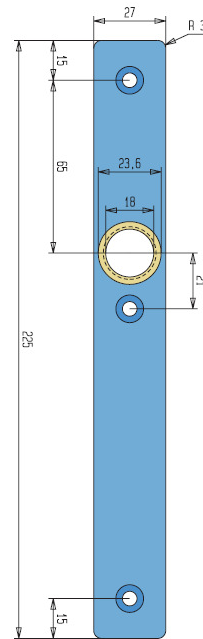

7) Langschild innen - blind

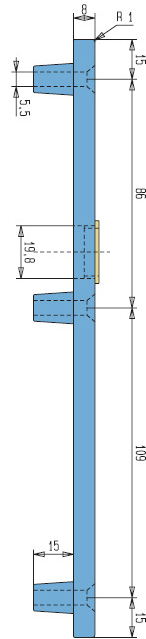

Pos.	Bezeichnung	Farbe EV1 Art.-Nr.	Farbe EV2 Art.-Nr.	Farbe WEISS Art.-Nr.
1	Langschild aussen Rundzylinder	NHBZ0040-524010	NHBZ0040-526010	NHBZ0040-504010
2	Langschild aussen Profilzylinder	NHBZ0050-524010	NHBZ0050-526010	NHBZ0050-504010
3	Langschild aussen blind	NHBZ0060-524010	NHBZ0060-526010	NHBZ0060-504010
4	Langschild aussen ganz blind	NHBZ0070-524010	NHBZ0070-526010	NHBZ0070-504010
5	Langschild innen Rundzylinder	NHBZ0010-524010	NHBZ0010-526010	NHBZ0010-504010
6	Langschild innen Profilzylinder	NHBZ0020-524010	NHBZ0020-526010	NHBZ0020-504010
7	Langschild innen blind	NHBZ0030-524010	NHBZ0030-526010	NHBZ0030-504010
8	Linsensenschraube M5x70	NDNA0190-0J0010		NDNA0190-102010
9	Linsensenschraube M5x80	NDNA0200-0J0010		NDNA0200-102010
10	Linsensenschraube M5x90	NDNA0210-0J0010		NDNA0210-102010

Fallenblech und Drücker



BEZEICHNUNG	SIEGENIA-AUBI	VPE
Fallenblech zu AS7170		
A0380 - EURONUT 6/8/3 mm	3188424	10
A0800 - EURONUT 7/8/4 mm	3125657	10
A0420 - 4 mm Falzluft, Falztiefe 17 mm	3216471	10
A1361 - EUROFALZ 18/8 mm	NRFR0100-100010	10
Eurodur / Rehau	3181486	10
Thyssen	3125682	10
Veka Softline	3344107	10



BEZEICHNUNG	SIEGENIA-AUBI	VPE
Drückergarnitur aussen hoch		
EV1		
70-90	NMTD0020-524010	10
EV2		
70-90	NMTD0020-526010	10
weiss		
70-90	NMTD0020-504010	10

EV1		
50-70	NMTD0010-524010	10
EV2		
50-70	NMTD0010-526010	10
weiss		
50-70	NMTD0010-504010	10



BEZEICHNUNG	SIEGENIA-AUBI	VPE
Drückergarnitur aussen nieder		
EV1		
70-90	NMTD0040-524010	10
EV2		
70-90	NMTD0040-526010	10

EV1		
50-70	NMTD0030-524010	10
EV2		
50-70	NMTD0030-526010	10