

Capuchon, compas, fermeture rallonge...

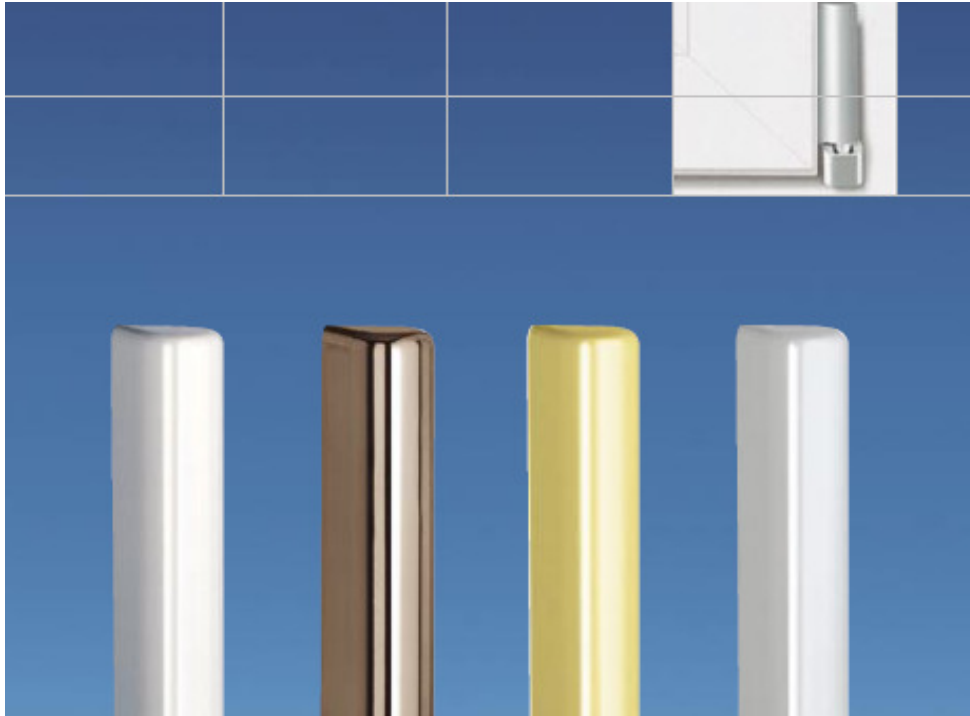

Exécutions:

- pour TITAN AF
- pour FAVORIT Si-line

capuchon W bois et PVC



DÉSIGNATION	SIEGENIA-AUBI		UQ
CAPUCHON FC BOIS			
TITAN			
CAPUCHON FC BOIS TITANE BRILLANT C100	233641	/ 839089	100
CAPUCHON FC BOIS TITANE CLAIR MAT C100	238950	/ 848616	100
CAPUCHON FC BOIS TITANE FONCE MAT C100	236109	/ 839720	100
BLANC			
CAPUCHON FC BOIS RAL9003 C100		FKWB0020-002060	100
BRUN			
CAPUCHON FC BOIS RAL8019 BRUN C500	226179	/ 833261	500
NOIR			
CAPUCHON FC BOIS RAL9005 NOIRE U1	-	/ 884072	1
ARGENT-SI			
CAPUCHON FC BOIS ARG.-SI C100		FKWB0020-025060	100
CHAMPAGNE-SI			
CAPUCHON FC BOIS CHAMP. S50/C500	247099	/ 857168	500
OR			
CAPUCHON W H OR MAT C100	294512	/ 888353	100
CAPUCHON FC BOIS OR BRILLANT C100	233269	/ 838730	100



DÉSIGNATION	SIEGENIA-AUBI		UQ
CAPUCHON FC PVC			
TITAN			
CAPUCHON FC PVC TITANE BRILLANT C100	234945	/ 842461	100
CAPUCHON FC PVC TITANE CLAIR MAT C100	238912	/ 848678	100
CAPUCHON FC PVC TITANE FONCE MAT C100	238974	/ 848692	100
BLANC			
CAPUCHON FC KF BLC RAL9003 C100		FKWB0010-002060	100
BRUN			
CAPUCHON FC KF BRUN RAL8019 C100		FKWB0010-011060	100
NOIR			
CAPUCHON FC PVC RAL9005 NOIRE C100	303658	/ 894125	100
ARGENT-SI			
CAPUCHON FC KF ARGT. SI C100		FKWB0010-025060	100
CHAMPAGNE-SI			
CAPUCHON FC PVC CHAMP. C500	247419	/ 857595	500
OR			
CAPUCHON FC PVC OR MAT ANC. C100	238943	/ -	100
CAPUCHON FC PVC OR BRILLANT C100	234938	/ 842461	100

capuchon S et S RFA A0175

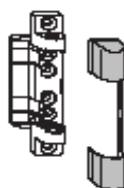
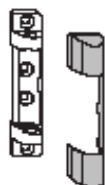

DÉSIGNATION	SIEGENIA-AUBI		UQ
CAPUCHON S			
TITAN			
CAPUCHON PC TITANE BRILLANT C100	233634	/ 839072	100
CAPUCHON PC TITANE CLAIR MAT C100	238929	/ 848586	100
CAPUCHON PC TITANE FONCE MAT C100	236093	/ 839713	100
BLANC			
CAPUCHON PC RAL9003 C100		FKSL0010-002060	100
BRUN			
CAPUCHON PC RAL8019 C100		FKSL0010-011060	100
NOIR			
CAPUCHON PC RAL9005 NOIRE C100	303702	/ 884065	100
ARGENT-SI			
CAPUCHON PC PCI-ARG. C100		FKSL0010-025060	100
CHAMPAGNE-SI			
CAPUCHON PC CHAMP. C500	247082	/ 857151	500
OR			
CAPUCHON 'S' OR MAT S50/C100	294482	/ 888322	100
CAPUCHON PC OR BRILLANT C100	233276	/ 838747	100

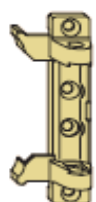

DÉSIGNATION	SIEGENIA-AUBI		UQ
CAPUCHON S RFA A0175			
TITAN			
CAP.PC POSE FEUIL.DT EX175 TIT.BRIL.C250	256992	/ 869529	250
CAP.PC POSE FEUIL.DT EX175 TIT.CL.MAT U1	-	/ 860540	1
CAP.PC POSE FEUIL.DT EX175 TIT.FC MAT U1	-	/ 868744	1
BLANC			
CAPUCHON PC FEUIL. DT EX175 RAL9003 C100		FKSL0050-002060	100
BRUN			
CAPUCHON PC POSE FEUIL.DT EX175 BRUNC250	249178	/ 860571	250
NOIR			
-	-	/ -	-
ARGENT-SI			
CAP. PC POSE FEUIL.DT EX175 NAT. C250	256657	/ 869192	250
CHAMPAGNE-SI			
CAP. PC POSE FEUIL.DT EX175 CHAMP. U1	-	/ 868126	1
OR			
CAP. S POSE FEUIL.DT EX175 OR MAT U1	-	/ 860557	1
CAP. PC POSE FEUIL.DT EX175 OR BRIL. U1	-	/ 868522	1

capuchon S KF S et FAF

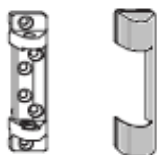

DÉSIGNATION	SIEGENIA-AUBI		UQ
CAPUCHON S KF-S			
TITAN			
CAPUCHON S KF-S TITAN MATT HELL K100	239018	/ 848708	100
BLANC			
CAPUCHON S KF-S RAL9003 K250	229101	/ 835821	250
BRUN			
CAPUCHON S KF-S RAL8019 K250	229125	/ 835838	250
CHAMPAGNE-SI			
CAPUCHON S KF-S SI-SILBER K100	FKSL0020-025060		100
OR			
CAPUCHON S KF-S GOLD GLAENZEND K100	234914	/ 842447	100



DÉSIGNATION	SIEGENIA-AUBI		UQ
CAPUCHON FAF			
TITAN			
CAPUCHON FAF DTE TITANE BRILLANT C100	294093	/ 887059	100
CAPUCHON FAF GCHE TIT. BRILLANT C100	294253	/ 887240	100
CAPUCHON FAF DTE TITANE CLAIR MAT C100	294116	/ 887073	100
CAPUCHON FAF GCHE TITANE CLAIR MAT C100	294277	/ 887264	100
CAP. FAF DTE TITAN MATT DUNKEL C100	294109	/ 887066	100
CAP. FAF GCHE TITAN MATT DUNKEL C100	294260	/ 887257	100
BLANC			
CAPUCHON FAF DTE RAL9003 C100	FKFE0011-002060		100
CAPUCHON FAF GCHE RAL9003 C100	FKFE0012-002060		100
BRUN			
CAPUCHON FAF DTE RAL8019 C100	FKFE0011-011060		100
CAPUCHON FAF GCHE RAL8019 C100	FKFE0012-011060		100
NOIR			
CAPUCHON FAF DTE RAL9005 NOIRE C100	303665	/ -	100
CAPUCHON FAF GCHE RAL9005 NOIRE C100	303672	/ -	100
ARGENT-SI			
CAPUCHON FAF DTE ARGENT C500	294086	/ 887042	500
CAPUCHON FAF GCHE ARGENT C500	294246	/ 887233	500
CHAMPAGNE-SI			
CAPUCHON FAF DTE CHAMP. C500	294123	/ 887080	500
CAPUCHON FAF GCHE CHAMP. C500	294284	/ 887271	500
OR			
CAPUCHON FAF DTE GOLD MATT C100	294147	/ 887103	100
CAPUCHON FAF GCHE OR MAT C100	294307	/ 887295	100
CAPUCHON FAF DTE OR BRILLANT C100	294130	/ 887097	100
CAP. FAF GCHE OR BRILLANT C100	294291	/ 887288	100

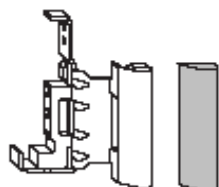
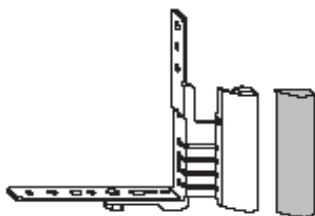

capuchon FA

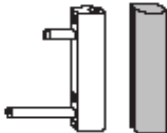

DÉSIGNATION	SIEGENIA-AUBI		UQ
CAPUCHON FA			
TITAN			
CAPUCHON FA TITANE BRILLANT C100	294895	/ 887431	100
CAPUCHON FA TITANE CLAIR MAT C100	294918	/ 887455	100
CAPUCHON FA TITANE FONCE MAT C100	294901	/ 887448	100
BLANC			
CAPUCHON FA RAL9003 C100	FKEB0020-002060		100
BRUN			
CAPUCHON FA RAL8019 BRUN C500	294963	/ 887547	500
NOIR			
-	-	/ -	-
ARGENT-SI			
CAPUCHON FA ARGENT C500	294888	/ 887424	500
CHAMPAGNE-SI			
CAPUCHON EB BRUN CHAMP. U1	-	/ 887462	1
OR			
CAP. EB OR MAT C100	294451	/ 887486	100
CAPUCHON FA OR BRILLANT C100	294925	/ 887479	100

capuchon BAS et BAS S



DÉSIGNATION	SIEGENIA-AUBI		UQ
CAPUCHON BAS PA			
TITAN			
CAPUCHON BAS PA TITANE BRILLANT C100	233627	/ 839065	100
CAPUCHON BAS PA TITANE CLAIR MAT C100	238806	/ 848463	100
CAPUCHON BAS PA TITANE FONCE MAT C100	236147	/ 839706	100
BLANC			
CAPUCHON BAS PA RAL9003 C100	FKEU0010-002060		100
BRUN			
CAPUCHON BAS PA RAL8019 C100	FKEU0010-011060		100
NOIR			
CAPUCHON BAS PA RAL9005 NOIRE C100	303696	/ 884058	100
ARGENT-SI			
CAPUCHON BAS PA ARGENT S50/C500	235751	/ 844342	500
CHAMPAGNE-SI			
CAPUCHON BAS PA BAS CHAMP. CA500	247075	/ 857144	500
OR			
CAP. EL BAS OR MAT C100	294475	/ 888315	100
CAPUCHON BAS PA PVC OR BRILLANT C100	FKEU0010-038060		100

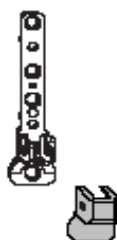

DÉSIGNATION	SIEGENIA-AUBI		UQ
CAPUCHON BAS PA S			
TITAN			
CAPUCHON BAS PA S TITANE BRILLANT C100	233665	/ 839102	100
CAPUCHON BAS PA S TITANE CLAIR MAT C100	238837	/ 848494	100
CAPUCHON BAS PA S TITANE FONCE MAT C100	238851	/ 848517	100
BLANC			
CAPUCHON BAS PA-S RAL9003 C100	FKEL0010-002060		100
BRUN			
CAPUCHON BAS PA-S RAL8019 C100	FKEL0010-011060		100
NOIR			
-	-	/ -	-
ARGENT-SI			
CAPUCHON BAS PA S ARGENT S50/C100	256701	/ 869123	100
CHAMPAGNE-SI			
-	-	/ -	-
OR			
CAPUCHON BAS PA S OR MAT U1		/ 848500	1
CAPUCHON BAS PA S OR BRILLANT C100	233658	/ 839096	100

capuchon EL O

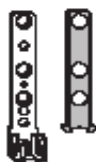

DÉSIGNATION	SIEGENIA-AUBI		UQ
CAPUCHON HAUT PA			
TITAN			
CAPUCHON HAUT PA TITANE BRILLANT C100	233610 /	839058	100
CAPUCHON HAUT PA TITANE CLAIR MAT C100	238776 /	848432	100
CAPUCHON PA HAUT TITANE FONCE MAT C100	236130 /	839690	100
BLANC			
CAPUCHON HT PA RAL9003 C100		FKEO0010-002060	100
BRUN			
CAPUCHON HT PA RAL8019 C100		FKEO0010-011060	100
NOIR			
CAPUCHON HAUT PA RAL9005 NOIRE C100	303689 /	838884	100
ARGENT-SI			
CAPUCHON HAUT PA ARGENT S50/C500	235744 /	844335	500
CHAMPAGNE-SI			
CAPUCHON HAUT PA CHAMP. S50/C500	251195 /	863251	500
OR			
CAP. EL HT. OR MAT C100	294468 /	888308	100
CAPUCHON HAUT PA PVC OR BRILLANT C100	233306 /	838778	100

capuchon FC

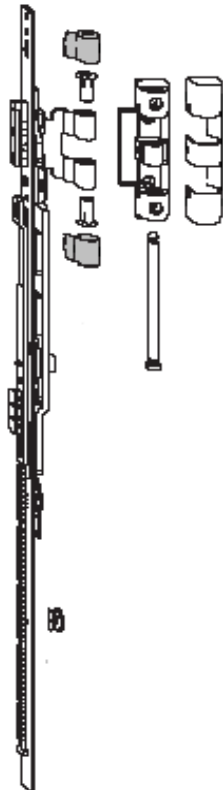

DÉSIGNATION	SIEGENIA-AUBI		UQ
CAPUCHON FC CINTRE			
TITAN			
CAP. FC DTE CINTRE TITANE BRILLANT C100	233696	/ 233696	100
CAP. FC GCHE PC TITANE BRILLANT C100	233719	/ 839188	100
CAP. FC CINTRE DTE TITANE MAT CLAIR C100	FKWB0041-034060		100
CAP.FC CINTRE GCHE TITANE MAT CLAIR C100	FKWB0042-034060		100
CAP. FC DTE CINTRE TITANE FONCE MAT U1		/ 850329	1
CAP. FC GCHE CINTRE TITANE FONCE MAT U1		/ 850350	1
BLANC			
CAPUCHON FC DTE CINTRE RAL9003 S50/C500	230152	/	500
CAPUCHON FC GCHE CINTRE RAL9003 S50/C500	230176	/	500
BRUN			
CAPUCHON FC DTE CINTRE RAL8019 S50/C500	230169	/ 837771	500
CAPUCHON FC GCHE CINTRE RAL8019 S50/C500	230183	/ 837795	500
NOIR			
CAP. FC DTE CINTRE RAL9005 NOIRE U1	202.5249.6001S20		1
ARGENT-SI			
CAPUCHON FC DTE CINTRE ARGENT S25/C100	240786	/	100
CAPUCHON FC GCHE CINTRE ARGENT C100	240847	/	100
CHAMPAGNE-SI			
CAPUCHON FC DTE CINTRE CHAMP. S25/C100	247167	/	100
CAPUCHON FC GCHE CINTRE CHAMP. S25/C100	247174	/ 857229	100
OR			
CAP. W DTE RB GOLD MATT U1		/ 891384	1
CAPUCHON FC GCHE CINTRE OR MAT U1		/ 850374	1
CAPUCHON FC DTE CINTRE OR BRILLANT C100	233702	/ 839171	100
CAPUCHON FC GCHE CINTRE OR BRILLANT C100	233726	/ 839195	100

capuchon PC 7

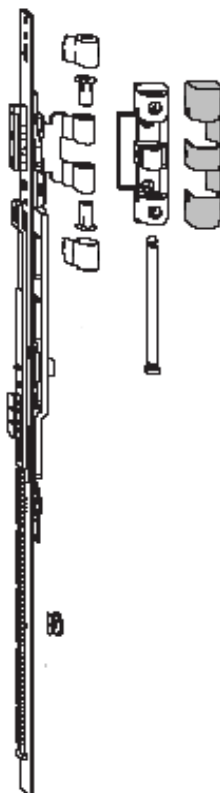
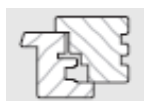

DÉSIGNATION	SIEGENIA-AUBI		UQ
CAPUCHON PC 7 CINTRE			
TITAN			
CAPUCHON PC 7 CINTRE TIT. BRIL. S50/C100	233672	/ 839140	100
CAP. PC 7 CINTRE TITANE CLAIR MAT U1		/ 850305	1
CAP. PC 7 RB TITANE FONCE MAT U1		/ 850299	1
BLANC			
CAP. PC 7 CINTRE RAL9003 BLC S50/C250	230138	/ 837740	250
BRUN			
CAP. PC 7 CINTRE RAL8019 BRUN S50/C250	230145	/ 837757	250
NOIR			
-	-	/ -	-
ARGENT-SI			
CAPUCHON PC 7 CINTRE ARGENT C100	240700	/ 850565	100
CHAMPAGNE-SI			
CAPUCHON PC 7 CINTRE CHAMP. S50/C100	247150	/ 857205	100
OR			
CAPUCHON PC 7 CINTRE OR MAT U1		/ 850312	1
CAPUCHON PC 7 CINTRE OR BRILLANT C100	233689	/ 839157	100

compas, compas additionnel

DÉSIGNATION	SIEGENIA-AUBI			UQ
COMPAS				
COMPAS F2 GR.0 TS K25	FFB 230 - 430 mm	FSKK1100-100040		25
- Avec RVA VS MINI	FFB 230 - 344 mm	FEUL0260-100041		25
- Mit RVA VS	FFB 345 - 430 mm	FEUL0250-100042		25

COMPAS F2 GR.1 TS K25	FFB 431 - 680mm	FSKK1010-100040		25
COMPAS F2 GR.2 1RS TS K25	FFB 681 - 850 mm	FSKK1120-100040		25
COMPAS F2 GR.3 1RS TS K25	FFB 851 - 1050 mm	FSKK1030-100040		25
COMPAS F2 GR.4 1RS TS K25	FFB 1051 - 1250 mm	FSKK1040-100040		25

GRT COMPAS ADDITIONNEL F2	FFB 1251 - 1560 mm	FMZS0040-100040		25
---------------------------	--------------------	-----------------	--	----

COMPAS F2 GR.3 1RS TS K25	FFB 1251 - 1450 mm	FSKK1030-100040		25
COMPAS F2 GR.4 1RS TS K25	FFB 1451 - 1560 mm	FSKK1040-100040		25



DÉSIGNATION	SIEGENIA-AUBI			UQ
KARTON ZUSATZSCHERE F2				
KARTON ZUSATZSCHERE F2 TS	FFB 1251 - 1450 mm	FMZS0040-100040		25
Inhalt:				
- ZWISCHENSTUECK ZUSATZSCHERE 1RS TS		FZOK0020-100010		
- ZUSATZSCHERE TS		/ 704035		
- KLEMMFEDER Z		202.5346.5001.A1		



compas TBT

DÉSIGNATION	SIEGENIA-AUBI		UQ
COMPAS 7/Z			
COMPAS 7/Z, droite	FFB 580 - 830 mm	FSZK0011-100020	10
COMPAS 7/Z, gauche	FFB 580 - 830 mm	FSZK0012-100020	10



DÉSIGNATION	SIEGENIA-AUBI		UQ
COMPAS			
avoir besoin composant			
tête de compas			
GR.1		FSSK0010-100040	25
FFB 431 - 680 mm			
GR.2 1RS		FSSK0120-100040	25
FFB 681 - 850 mm			
GR.2		FSSK0020-100040	25
FFB 681 - 850 mm			
GR.3 1RS		FSSK0030-100040	25
FFB 851 - 1050 mm			
GR.4 1RS		FSSK0040-100040	25
FFB 1051 - 1250 mm			



DÉSIGNATION	SIEGENIA-AUBI		UQ
bras de compas			
GR.1		TSAT0010-100040	25
FFB 431 - 680 mm			
GR.2		TSAT0020-100040	25
FFB 681 - 850mm			
GR.3		TSAT0030-100040	25
FFB 851 - 1560			



compas additionnel

DÉSIGNATION	SIEGENIA-AUBI	UQ
Compas additionnel F2 RB RS TS	FMZS0100-100040	25
Inhalt:		
- ZUSATZSCHERE VS-RB A0760 TS		
- ZWISCHENSTUECK ZS RB 1RS TS	FZVK0010-100010	

Compas additionnel

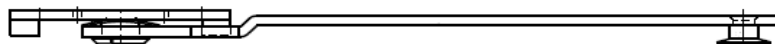

Pièce intercalaire

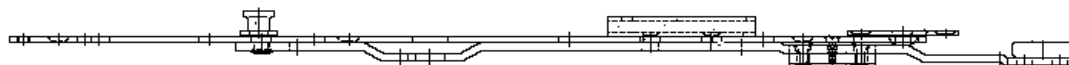

bras de compas

DÉSIGNATION		SIEGENIA-AUBI	UQ
TÊTIÈRE DE COMPAS DF/ON TA	FFB 431-1560 mm	TSSD0030-100060	100

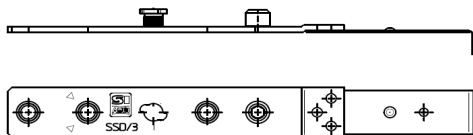

DÉSIGNATION		SIEGENIA-AUBI	UQ
BRAS DE COMPAS DF TA	FFB 431-1560 mm	TSAD0010-100061	100

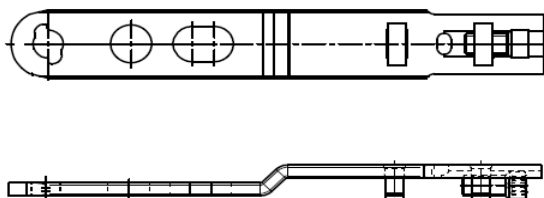

DÉSIGNATION		SIEGENIA-AUBI	UQ
TETIÈRE DE COMPAS IP DF TA	FFB 431-1560 mm	TSSD0020-100060	100

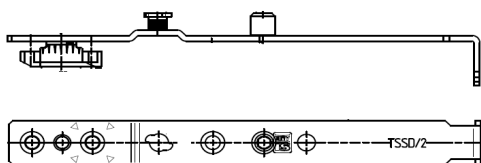

renvoi d'angle

DÉSIGNATION		SIEGENIA-AUBI	UQ
Renvoi d'angle ES040/STULP 1RS TS		FMEU0050-100040	25

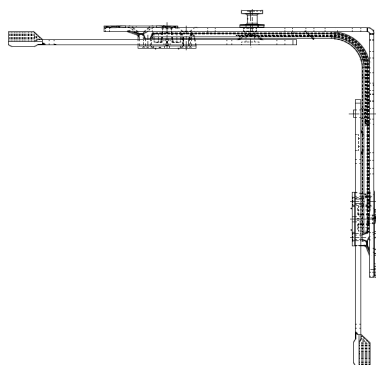

DÉSIGNATION		SIEGENIA-AUBI	UQ
Renvoi d'angle VSO SP 1RS TS		FEUL0300-100040	25

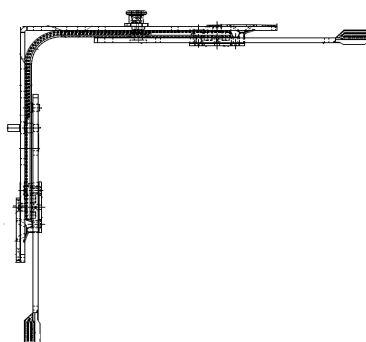

DÉSIGNATION		SIEGENIA-AUBI	UQ
Renvoi d'angle VS 1RS KLEMMBAR TS		FEUL0250-100041	25

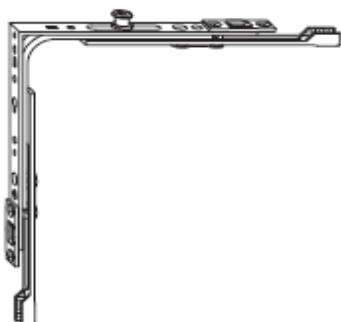

renvoi d'angle

DÉSIGNATION	SIEGENIA-AUBI	UQ
Renvoi d'angle VS A0055 2RS TS	FEUL0270-100040	25

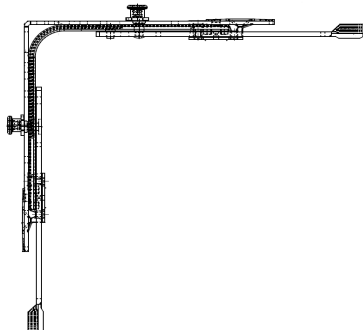

DÉSIGNATION	SIEGENIA-AUBI	UQ
Renvoi d'angle VSO A0089 SCHMAL TS schmal, 2 Flg.	278666 / 702932	25



DÉSIGNATION	SIEGENIA-AUBI	UQ
Renvoi d'angle VS SCHMAL 1RS TS	FEUL0260-100040	25

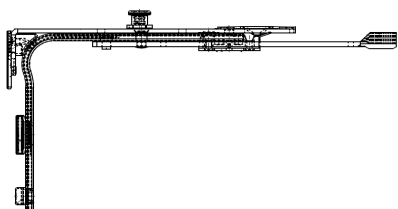

DÉSIGNATION	SIEGENIA-AUBI	UQ
Renvoi d'angle VSO-DS 1RS TS	FEUL0470-100040	25

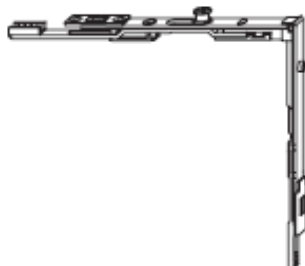

renvoi d'angle

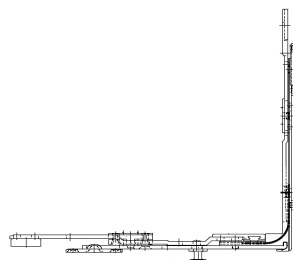

DÉSIGNATION	SIEGENIA-AUBI		UQ
RENVOI D'ANGLE VS-DS S-ES A0149 TS K25			
Für FFB <302 mm	278765	/ 703021	25

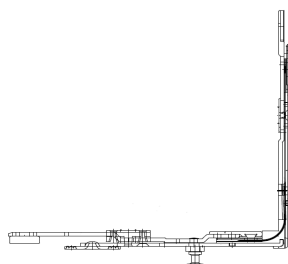

DÉSIGNATION	SIEGENIA-AUBI		UQ
RENVOI D'ANGLE A0273			
UMLENKUNG F2 VSU DS 1S A0273 TS K25	FEUL1240-100040		25
140mm x 140 mm			
Zahnung: Favorit			
In Kombination mit KRL SL-S FRKU....			

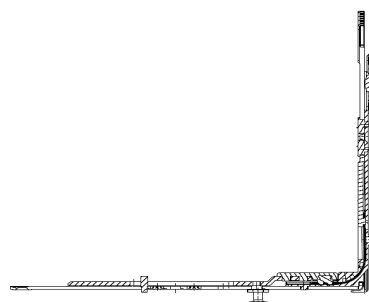

DÉSIGNATION	SIEGENIA-AUBI		UQ
UMLENKUNG AF VSU/K+ DS 1S TS K25			
140mm x 210 mm	TEUL1230-100040		25

renvoi d'angle

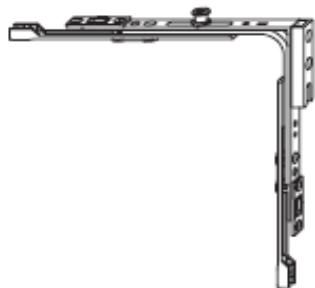

DÉSIGNATION		SIEGENIA-AUBI	UQ
Renvoi d'angle VSO STULP WK2 1RS		FEUL0410-100040	25



DÉSIGNATION		SIEGENIA-AUBI	UQ
Renvoi d'angle VSU RS STULP WK2 TS K25		FMEU1000-100040	25

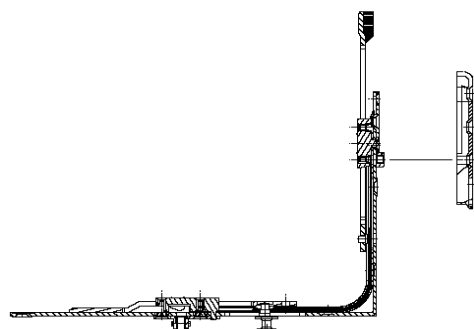

DÉSIGNATION		SIEGENIA-AUBI	UQ
UMLENKUNG F2 VSU/K+ STULP WK2 1S TS K25		FMEU1010-100040	25



DÉSIGNATION		SIEGENIA-AUBI		UQ
Renvoi d'angle VS S-ES				
A0102 TS		FEUL0100-100040		25

renvoi d'angle

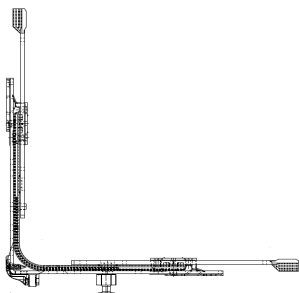

DÉSIGNATION	SIEGENIA-AUBI		UQ
ECKUMLENKUNG A0273			
ECKUMLENKUNG VSU S-ES FH/13 A0273 TS K25	FEUL1230-100040		25
140mm x 140 mm			
Zahnung: Favorit			

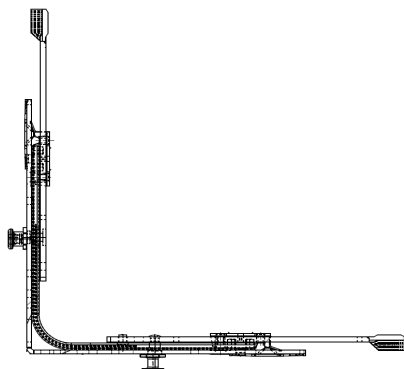

DÉSIGNATION	SIEGENIA-AUBI		UQ
UMLENKUNG VSU A0055 1S 1RS TS K25			
UMLENKUNG VSU A0055 1S 1RS TS K25	FEUL1150-100040		25

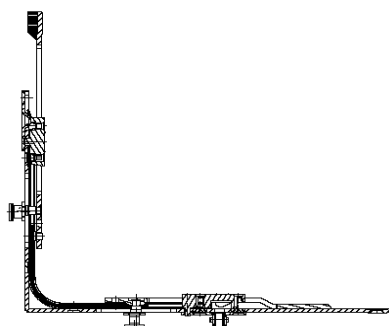

DÉSIGNATION	SIEGENIA-AUBI		UQ
UML. F2 VSU/K+ A0055 FH 1S 1RS TS K25			
UML. F2 VSU/K+ A0055 FH 1S 1RS TS K25	FEUL1210-100040		25
mit montierten FH, für 9 und 13 mm NL verwendbar			

renvoi d'angle



DÉSIGNATION	SIEGENIA-AUBI			UQ
Eckumlenkung VSU S-ES FH/9				
mit Flügelheber, Nutachse 9 mm	FEUL1070-100040			25
STATUS AUSLAUF				
Nachfolger:	FEUL1200-100040			

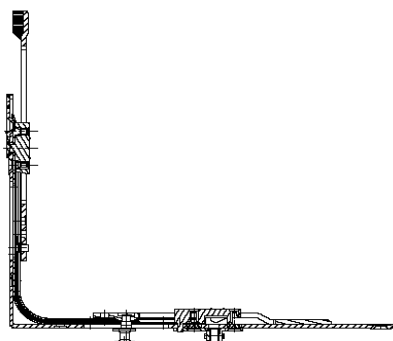

DÉSIGNATION	SIEGENIA-AUBI			UQ
UMLENKUNG F2 VSU/K+ FH 1S TS K25				
mit montierten FH, für 9 und 13 mm NL verwendbar	FEUL1200-100040			25

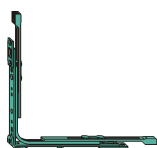

DÉSIGNATION	SIEGENIA-AUBI			UQ
Renvoi d'angle VSU S-ES FH/13				
mit Flügelheber, Nutachse 13 mm	FEUL1080-100040			25

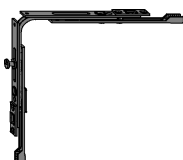

DÉSIGNATION	SIEGENIA-AUBI			UQ
Renvoi d'angle VSO/SF S-ES				
für Schrägenster	FEUL0130-100040			25

renvoi d'angle

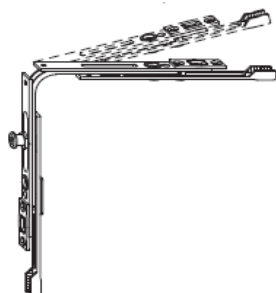

DÉSIGNATION		SIEGENIA-AUBI	UQ
Renvoi d'angle VSO SF 1RS TS K25		FEUL0280-100040	25

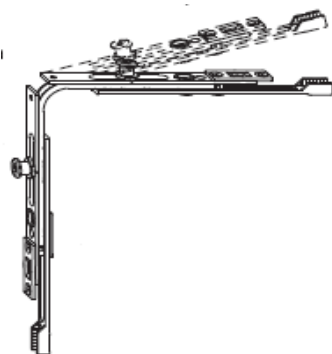

DÉSIGNATION		SIEGENIA-AUBI	UQ
Renvoi d'angle VSO SF A0055 2RS TS K25		FEUL0400-100040	25

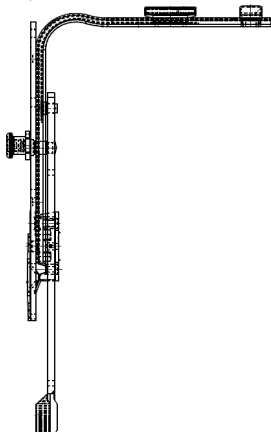

DÉSIGNATION		SIEGENIA-AUBI	UQ
Renvoi d'angle VSO SF SCHMAL 1RS TS K25		FEUL0290-100040	25

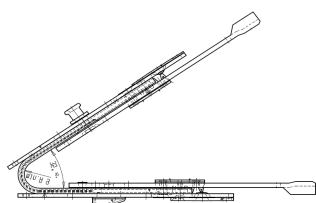

DÉSIGNATION		SIEGENIA-AUBI	UQ
Renvoi d'angle VSU-DEF 1RS TS K10		FEUL1180-100020	10

renvoi d'angle

DÉSIGNATION	SIEGENIA-AUBI	UQ
Renvoi d'angle RB 1RS STULPF/STICHB TS K25	FEUL0420-100040	25
vantail semi-fixe		
demi-cintre		

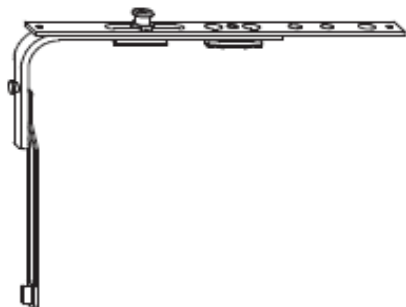

DÉSIGNATION	SIEGENIA-AUBI	UQ
Renvoi d'angle VSU RB 1S 1RS TS K25	FEUL1160-100040	25

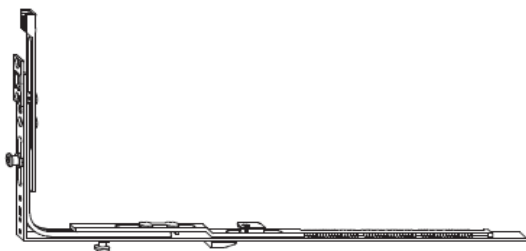

DÉSIGNATION	SIEGENIA-AUBI	UQ
Renvoi d'angle BSU H-18-20		
ohne MV	278857 / 703106	25

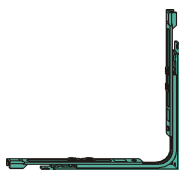

DÉSIGNATION	SIEGENIA-AUBI	UQ
Füllstulp		
für Eckumlenkung VSO und VSU	305324 / 718230	250



renvoi d'angle BSU S-ES bois et PVC

DÉSIGNATION	SIEGENIA-AUBI	UQ
H-4/15-9 GBA TS		
ECKUML.BSU S-ES LI H-4/15-9 GBA TS	FEUL3052-100040	25
ECKUML.BSU S-ES RE H-4/15-9 GBA TS	FEUL3051-100040	25
H 18-9 TS		
ECKUMLENKUNG BSU S-ES LI H 18-9 TS	FEUL3022-100040	25
ECKUMLENKUNG BSU S-ES RE H 18-9 TS	FEUL3021-100040	25
H 18-13 TS		
ECKUMLENKUNG BSU S-ES LI H 18-13 TS	FEUL3062-100040	25
ECKUMLENKUNG BSU S-ES RE H 18-13 TS	FEUL3061-100040	25
H 20-9 TS		
ECKUMLENKUNG BSU S-ES LI H 20-9 TS	FEUL3042-100040	25
ECKUMLENKUNG BSU S-ES RE H 20-9 TS	FEUL3041-100040	25
H 20-13 TS		
ECKUML.BSU S-ES H 20-13 LI.TS	FEUL3012-100040	25
ECKUML.BSU S-ES H 20-13 RE.TS	FEUL3011-100041	25

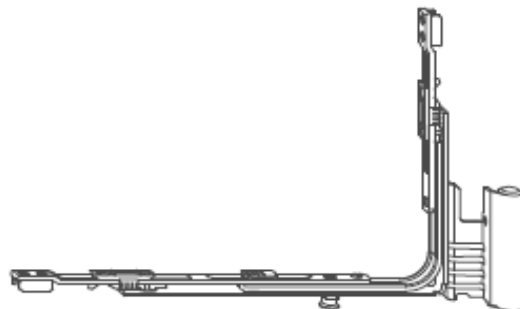

DÉSIGNATION	SIEGENIA-AUBI	UQ
KF-12/20-9 TS		
ECKUML.BSU S-ES KF-12/20-9 RE TS K25	289594 / 710388	25
ECKUML.BSU S-ES KF-12/20-9 LI TS K25	289617 / 710494	25
KF-12/20-13 TS		
ECKUML.BSU S-ES KF-12/20-13 RE TS K25	FEUL3081-100040	25
ECKUML.BSU S-ES KF-12/20-13 LI TS K25	FEUL3082-100040	25

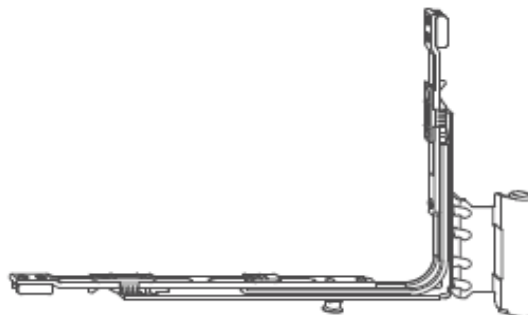

renvoi d'angle



DÉSIGNATION		SIEGENIA-AUBI	UQ
Renvoi d'angle BS/K3 GR.1+ 2RS TS K25		TEUL2380-100041	25
2 S-RS goupille			

Renvoi d'angle BS/K3 GR.2+ 2RS TS K25		TEUL2390-100042	25
2 S-RS goupille			

DÉSIGNATION		SIEGENIA-AUBI	UQ
SECU. ANTI DEGONDAGE 9 MM TA C25		TFAH0060-100040	25
NL 9mm			
SECU. ANTI DEGONDAGE 9 MM TA C25		TFAH0010-100040	25
NL 13 mm			

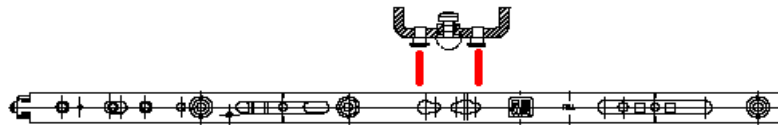

DÉSIGNATION		SIEGENIA-AUBI	UQ
Renvoi d'angle BSO/K3+ 1RS TS K25		TEUL2400-100040	25
1 S-RS goupille			

DÉSIGNATION		SIEGENIA-AUBI	UQ
Renvoi d'angle BS/K3 GR.1+ 1RS TS K25		TEUL2410-100041	25
1 S-RS goupille			

DÉSIGNATION		SIEGENIA-AUBI	UQ
Renvoi d'angle BS/K3 GR.2+ 1RS TS K25		TEUL2420-100042	25
1 S-RS goupille			

renvoi d'angle

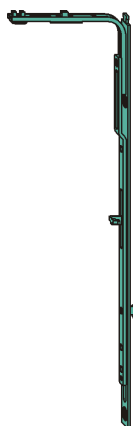

DÉSIGNATION	SIEGENIA-AUBI		UQ
Renvoi d'angle VSU/BS			
Gr. 50, 800-1200 mm	278147	/ 702550	25
Gr. 70, 1000-1400 mm	278161	/ 702567	25
Gr. 90, 1400-1560 mm	278185	/ 702574	25
Gr. 130, 1800-2360 mm	278789	/ 703045	25

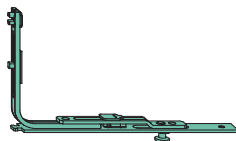

DÉSIGNATION	SIEGENIA-AUBI		UQ
Renvoi d'angle BS S-ES			
Gr. 20, 480-600 mm	278918	/ 703168	25

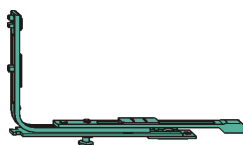

DÉSIGNATION	SIEGENIA-AUBI		UQ
Renvoi d'angle			
Renvoi d'angle VSU S-ES	278543	/ 702857	25

verrou



DÉSIGNATION		SIEGENIA-AUBI		UQ
Verrou VSO 90 GRAD 1RS TS K50		FESC0050-100050		50

DÉSIGNATION		SIEGENIA-AUBI		UQ
Verrou pivot TS K25				
180°		276372 /	701072	25

DÉSIGNATION		SIEGENIA-AUBI		UQ
Verrou TS K50				
90°		279014 /	703243	50

DÉSIGNATION		SIEGENIA-AUBI		UQ
Verrou mouvement inverse TS				
90°		279038 /	703250	50

DÉSIGNATION		SIEGENIA-AUBI		UQ
Verrou S-ES 180GRAD TS				
180°		295816 /	713624	25

DÉSIGNATION		SIEGENIA-AUBI		UQ
Verrou S-ES 90GRAD TS				
90°		295830 /	713631	25

DÉSIGNATION		SIEGENIA-AUBI		UQ
Verrou S-ES 180GRAD WEITERK.TS				
180°		302408 /	717448	50