

POIGNÉE PORTAL



Exécutions:

- HS PORTAL

poignée



DÉSIGNATION	SIEGENIA-AUBI		UQ
Poignée Si-line PSK 32			
éloxé EV-1, tige 32 mm	259030	/ 872086	10
éloxé EV-2, tige 32 mm	247846	/ 858257	10
blanc RAL 9003, tige 32 mm	247853	/ 858264	10
brun RAL 8022, tige 32 mm	306772	/ 895634	10
brun RAL 8019, tige 32 mm	247860	/ 858271	10
titan mat foncé, tige 31 mm	267738	/	10
F-9 couleur INOX, tige 31 mm	PHIJ0010-5H4020		10

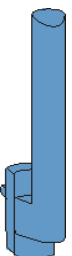

DÉSIGNATION	SIEGENIA-AUBI		UQ
Poignée Si-line PSK 35			
éloxé EV-1, tige 35 mm	262900	/ 875902	10
éloxé EV-2, tige 35 mm	262917	/ 875919	10
blanc RAL 9003, tige 35 mm	262924	/ 875926	10
brun RAL 8022, tige 35 mm	306796	/ 895689	10

POIGNÉE SI-LINE PSK 38 RAL9003 BLANC	PHIJ0080-502020	10
POIGNÉE SI-LINE PSK 38 EV1	PHIJ0080-524020	10



DÉSIGNATION	SIEGENIA-AUBI		UQ
Poignée à cylindre Si-line PSK 32			
éloxé EV-1, tige 32 mm	259047	/ 872093	10
éloxé EV-2, tige 32 mm	247891	/ 858301	10
blanc RAL 9003, tige 32 mm	247907	/ 858318	10
brun RAL 8022, tige 32 mm	306789	/ 895641	10
brun RAL 8019, tige 32 mm	247914	/ 858325	10
titan mat foncé, tige 31 mm	267899	/	10



DÉSIGNATION	SIEGENIA-AUBI		UQ
PGNEE PSK EXT. PLATE			
éloxé EV-1	874257	/ 874257	10
éloxé EV-2	874264	/ 874264	10
blanc RAL 9003	874271	/ 874271	10
brun RAL 8022	895665	/ 895665	10
brun RAL 8019	874288	/ 874288	10

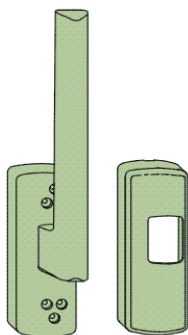

DÉSIGNATION	SIEGENIA-AUBI		UQ
Carton de poignée PSK 200-Z/GH			
éloxé EV-1, droite	296257	/	1
éloxé EV-1, gauche	296301	/	1
éloxé EV-2, droite	296264	/	1
éloxé EV-2, gauche	296318	/	1
blanc RAL 9003, droite	296271	/	1
blanc RAL 9003, gauche	296325	/	1
brun RAL 8022, droite	297797	/	1
brun RAL 8022, gauche	297803	/	1
F-9 couleur INOX, droite	PHIL0031-5H4010		1
F-9 couleur INOX, gauche	PHIL0032-5H4010		1

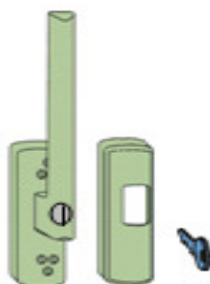

DÉSIGNATION	SIEGENIA-AUBI		UQ
Carton de poignée PSK 200-Z/GH avec cylindre			
éloxé EV-1, droite	296356	/	1
éloxé EV-1, gauche	296400	/	1
blanc RAL 9003, droite	296370	/	1
blanc RAL 9003, gauche	296424	/	1
brun RAL 8022, droite	298510	/	1
brun RAL 8022, gauche	298527	/	1
F-9 couleur INOX, droite	PHIL0041-5H4010		1
F-9 couleur INOX, gauche	PHIL0042-5H4010		1

poignée



Vieux emballage

DÉSIGNATION	SIEGENIA-AUBI	UQ
POIGNÉE SI-LINE HSK250		
NATUREL C1 éloxé EV-1, intérieur, sans trou (Vieux emballage PMHC0010-524010)	PMHC0010-524010	1

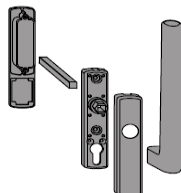

DÉSIGNATION	SIEGENIA-AUBI	UQ
RAL9003 C1 blanc RAL 9003, intérieur, sans trou	PMHC0010-502010	1
(Vieux emballage PMHC0010-502010)		

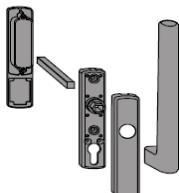

DÉSIGNATION	SIEGENIA-AUBI	UQ
RAL8022 C1 brun RAL 8022, intérieur, sans trou	PMHC0010-512010	1
(Vieux emballage PMHC0010-512010)		

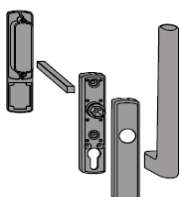

poignée



Vieux emballage

DÉSIGNATION	SIEGENIA-AUBI		UQ
Carton de poignée Si-Line HSK 250 / PSK 200-Z			
RZ A0089 I. EV1 K1	PMHC0040-524011		1
(Vieux emballage PMHC0040-524010)			

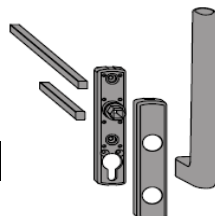

DÉSIGNATION	SIEGENIA-AUBI		UQ
RZ A0089 I.RAL9003K1			
POIGNEE HSK250-PSK200 RZ A0089 I.RAL9003K1	PMHC0040-502011		1
(Vieux emballage PMHC0040-502010)			

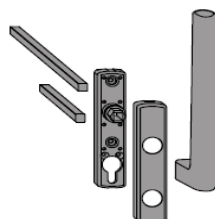

poignée

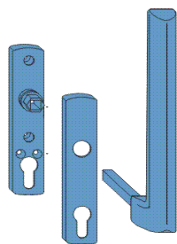

Vieux emballage

DÉSIGNATION	SIEGENIA-AUBI	UQ
Carton de poignée Si-Line HSK 250 / PSK 200-Z		
éloxé EV-1, Hahn (Vieux emballage PMHC0020-524010)	PMHC0020-524011	1

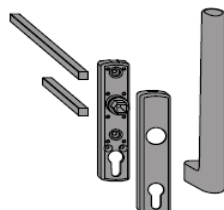

DÉSIGNATION	SIEGENIA-AUBI	UQ
blanc RAL 9003, Hahn (Vieux emballage PMHC0020-502010)	PMHC0020-502011	1

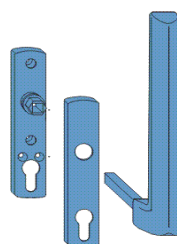
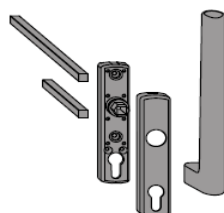

Vieux emballage

DÉSIGNATION	SIEGENIA-AUBI	UQ
brun RAL 8022, Hahn	PMHC0020-512010	1

poignée



Vieux emballage

DÉSIGNATION	SIEGENIA-AUBI	UQ
Carton de poignée Si-Line PSK 200-Z ext. Basse		
éloxé EV-1, borgne	NHIL0010-524010	1
blanc RAL 9003, borgne	NHIL0010-502010	1
brun RAL 8022, borgne	NHIL0010-512010	1
éloxé EV-1, KABA	307205 /	1
blanc RAL 9003, KABA	307212 /	1
éloxé EV-1, Hahn	PHAL0010-524010	1
blanc RAL 9003, Hahn	PHAL0010-502010	1
brun RAL 8022, Hahn	PHAL0010-512010	1

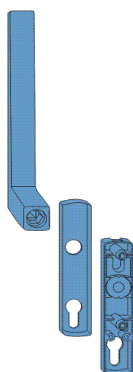

Vieux emballage

DÉSIGNATION	SIEGENIA-AUBI	UQ
Carton de poignée Si-Line HS 250 ext. Haute		
éloxé EV-1, KABA	PMHB0120-524010	1
blanc RAL 9003, KABA	PMHB0120-502010	1
brun RAL 8022, KABA	/ 896013	1
éloxé EV-1, Hahn		
blanc RAL 9003, Hahn	PMHB0040-502011	1
(Vieux emballage PMHB0040-502010)		

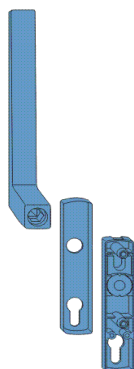
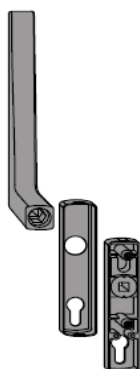

Vieux emballage

DÉSIGNATION	SIEGENIA-AUBI	UQ
brun RAL 8022, Hahn	PMHB0040-512010	1

poignée



DÉSIGNATION	SIEGENIA-AUBI		UQ
Poignée Si-line HS 150 intérieur			
EV-1, éloxé Alu	249550	/ 861479	10
EV-2, champagne	249567	/ 861486	10
blanc, RAL 9003	249574	/ 861493	10
brun, RAL 8019	249581	/ 861509	10



DÉSIGNATION	SIEGENIA-AUBI		UQ
Poignée Si-line HS 150 intérieur sans tige			
EV-1, éloxé Alu		/ 874202	1
blanc, RAL 9003		/ 874226	1
brun, RAL 8019		/ 874233	1



DÉSIGNATION	SIEGENIA-AUBI		UQ
Poignée Si-line HS 150 intérieur à cylindre			
EV-1, éloxé Alu	249604	/ 861523	1
EV-2, champagne	249611	/ 861530	1
blanc, RAL 9003	249628	/ 861547	1



DÉSIGNATION	SIEGENIA-AUBI		UQ
Poignée cuvette Si-line HS 150			
F-1	260807	/ 873922	10
F-2	260814	/ 880845	10
blanc RAL 9003	260821	/ 880852	10
brun RAL 8019	260838	/ 880876	10

poignée

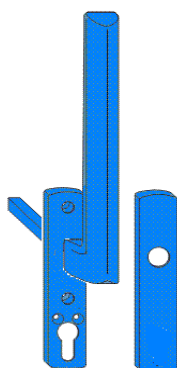

Vieux emballage

DÉSIGNATION	SIEGENIA-AUBI		UQ
Poignée Si-line HS 300 intérieur			
A0089 EV1 K1	IB0110-52	10-524011	1
(Vieux emballage PMHB0110-524010)			

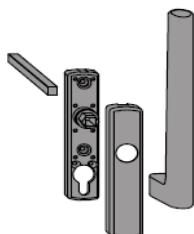

DÉSIGNATION	SIEGENIA-AUBI		UQ
Poignée Si-line HS 300 intérieur			
(Vieux emballage PMHB0110-502010)			
	PMHB0110-502011		1

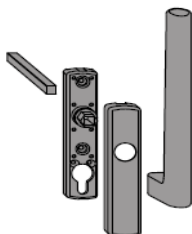

DÉSIGNATION	SIEGENIA-AUBI		UQ
Poignée Si-line HS 300 intérieur			
EV-2, sans trou	268179 /		1

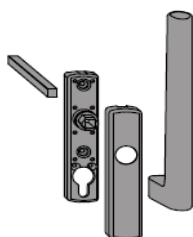

DÉSIGNATION	SIEGENIA-AUBI		UQ
POIGNÉE SI-LI.HS300 A0089 I. F9 (INTÉRIEUR)			
F9 Stahlfarbig , seulement trou pour poignée			
(Vieux emballage HIB0010-5H4010)			
Content:			
- Poignée avec capuchon intérieur			
- Capuchon (seulement trou pour la poignée)			
- 4 Kantstift 90 X 10 X 10 mm			
	PMHB0110-5H4011		1

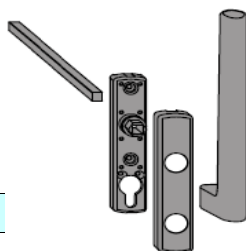

DÉSIGNATION	SIEGENIA-AUBI		UQ
POIGNÉE SI-LI.HS300 RZ A0089 I. F9 (INTÉRIEUR)			
F9 Stahlfarbig , Avec trou pour Poignée + capuchon			
(Vieux emballage HIB0010-5H4010)			
Content:			
- Poignée avec capuchon			
- Capuchon (Trou pour poignée + Cylindre)			
- 4 Kantbolzen 170 X 10 X 10 mm in TS			
	PMHB0130-5H4010		1

poignée

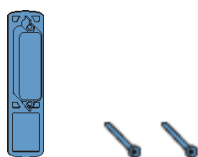

DÉSIGNATION	SIEGENIA-AUBI		UQ
Poignée cuvette Si-line longue			
F-1	273326	/ 880838	10
F-2	273333	/ 873939	10
blanc RAL 9003	273340	/ 880852	10

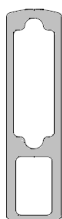

DÉSIGNATION	SIEGENIA-AUBI		UQ
DICHTUNGSPLATTE SELBSTKL.		/	881798

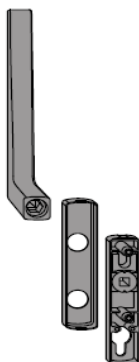

DÉSIGNATION	SIEGENIA-AUBI		UQ
HEBEL SI-LI.HS300 RZ A0089 A. EV1			
EV1, Mit Lochung für den Hebel + Rundzylinder	PMHB0120-524011		1
HEBEL SI-LI.HS300 RZ A0089 A. EV1 K1			
Inhalt:			
- Hebel HS300 RZ aussen			
- Abdeckkappe Si-line HS 300 RZ			

BEZEICHNUNG	SIEGENIA-AUBI		VPE
HEBEL SI-LI.HS300 RZ A0089 A. F9 K1			
F9 Stahlfarbig, Mit Lochung für den Hebel + Rundzylinder	PMHB0120-5H4010		1
Inhalt:			
- Hebel mit Rosette aussen			
- Abdeckkappe (Lochung für Hebel und Rundzylinder)			

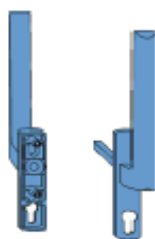

BEZEICHNUNG	SIEGENIA-AUBI		VPE
Innen, Abdeckkappe Ausschnitt Rundzylinder			
HEBEL SI-LI.HS300 RZ A0089 I. EV1 K1	PMHB0130-524011		1
(Alte Packung PMHB0130-524010)			

Vieux emballage

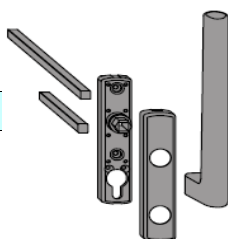

poignée

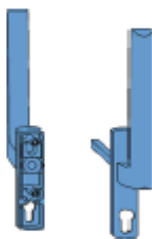

Vieux emballage

DÉSIGNATION	SIEGENIA-AUBI		UQ
Extérieur, Abdeckkappe Ausschnitt Rundzylinder			
HEBEL SI-LI.HS300 RZ A0089 A. RAL9003	PMHB0120-502011		1
(Vieux emballage PMHB0120-502010)			

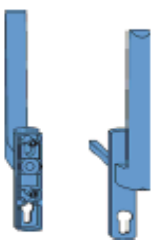
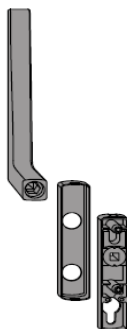

Vieux emballage

DÉSIGNATION	SIEGENIA-AUBI		UQ
Intérieur, Abdeckkappe Ausschnitt Rundzylinder			
HEBEL SI-LI.HS300 RZ A0089 I. RAL9003	PMHB0130-502011		1
(Vieux emballage PMHB0130-502010)			

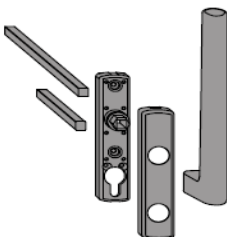

poignée

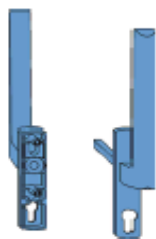

Vieux emballage

DÉSIGNATION	SIEGENIA-AUBI		UQ
Extérieur, Abdeckkappe Ausschnitt Profilzylinder			
HEBEL SI-LI.HS300 PZ A. EV1	PMHB0040-524011		1
(Vieux emballage PMHB0040-524010)			

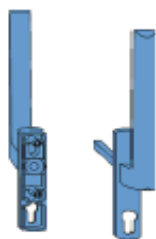
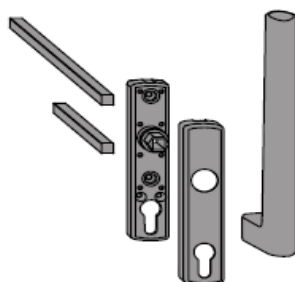

Vieux emballage

DÉSIGNATION	SIEGENIA-AUBI		UQ
Intérieur, Abdeckkappe Ausschnitt Profilzylinder			
HEBEL SI-LI.HS300 PZ I. EV1	PMHB0050-524011		1
(Vieux emballage PMHB0050-524010)			

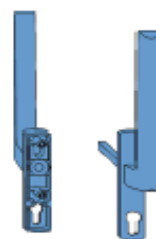
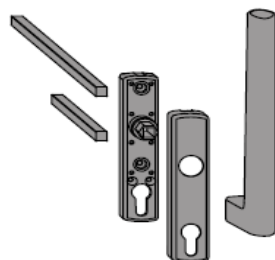

Vieux emballage

DÉSIGNATION	SIEGENIA-AUBI		UQ
Extérieur, Abdeckkappe Ausschnitt Profilzylinder			
HEBEL SI-LI.HS300 PZ A. RAL9003	PMHB0040-502011		1
(Vieux emballage PMHB0040-502010)			

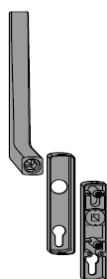

poignée

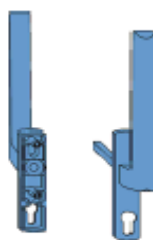

Vieux emballage

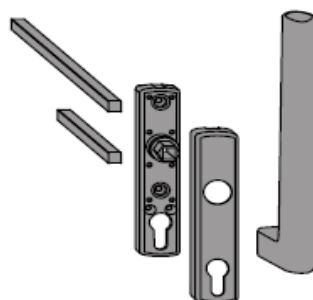

DÉSIGNATION	SIEGENIA-AUBI	UQ
Intérieur, Abdeckkappe Ausschnitt Profilzylinder		
HEBEL SI-LI.HS300 PZ I. RAL9003 (Vieux emballage PMHB0050-502010)	PMHB0050-502011	1

poignée



DÉSIGNATION	SIEGENIA-AUBI		UQ
rosette de recouvrement Si-line			
EV-1, extérieure	PHZB0030-525010		1
blanc RAL 9003, extérieure		/ 881590	1
EV-2, extérieure		/ 881637	1
EV-1, intérieur	PHZB0020-525010		1
blanc RAL 9003, intérieur	PHZB0020-502010		1



DÉSIGNATION	SIEGENIA-AUBI		UQ
rosette de recouvrement Si-line			
EV-1, intérieur		/ 845752	1
EV-2, intérieur		/ 845776	1
blanc RAL 9003, intérieur		/ 845783	1



DÉSIGNATION	SIEGENIA-AUBI		UQ
Poignée HS mobil			
EV-2, intérieur		/ 827703	1
Poignée HS300 mobil			
Poignée SI-LINE HS300 mobil, blanc	PHIB0060-502010		1
blanc, intérieur			



DÉSIGNATION	SIEGENIA-AUBI		UQ
Capuchon			
Capuchon SANS trou pour Zylinder			
Capuchon SI-LINE HS300 EV1	PKHB0050-524010		1
Capuchon SI-LINE HS300 RAL9003	PKHB0050-502010		1
Capuchon avec trou pour Rundzylinder			
Capuchon SI-LINE HS300 RZ A0089 EV1	PKHB0060-524010		1
Capuchon SI-LINE HS300 RZ A0089 RAL9003	PKHB0060-502010		1
Capuchon avec trou pour Profilzylinder			
Capuchon SI-LINE HS300 PZ EV1	PKHB0040-524010		1
Capuchon SI-LINE HS300 PZ RAL9003	PKHB0040-502010		1

poignée

DÉSIGNATION	SIEGENIA-AUBI	UQ
poignée SI-LI.HS300 RAL9003 blanc K1	PMHB0010-502011	1
(Vieux emballage PMHB0010-502011)		

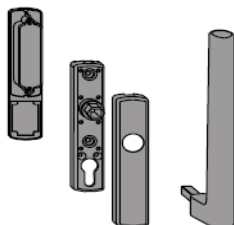

DÉSIGNATION	SIEGENIA-AUBI	UQ
poignée SI-LI.HS300 RAL8019 brun K1	PMHB0010-511011	1
(Vieux emballage PMHB0010-511011)		

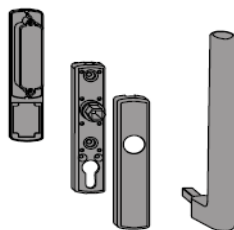

DÉSIGNATION	SIEGENIA-AUBI	UQ
poignée HEBEL SI-LI.HS300 EV1 K1	PMHB0010-524011	1
(Vieux emballage PMHB0010-524011)		

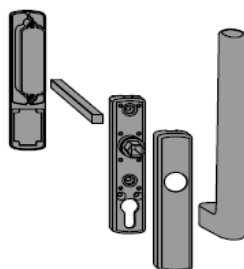

poignée

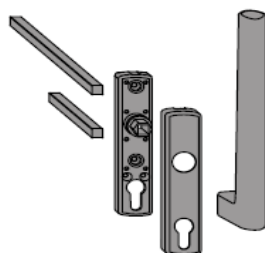

DÉSIGNATION	SIEGENIA-AUBI	UQ
poignée SI-LI.HS300 PZ I. RAL9005 K1	PMHB0050-523011	1
(Vieux emballage PMHB0050-523010)		

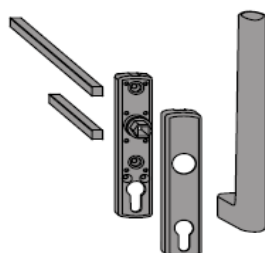

DÉSIGNATION	SIEGENIA-AUBI	UQ
poignée SI-LI.HS300 PZ I. EV2 K1	PMHB0050-526011	1
(Vieux emballage PMHB0050-526010)		

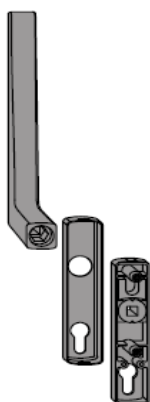

DÉSIGNATION	SIEGENIA-AUBI	UQ
poignée SI-LI.HS300 PZ A. RAL9005 K1	PMHB0040-523011	1
(Vieux emballage PMHB0040-523010)		

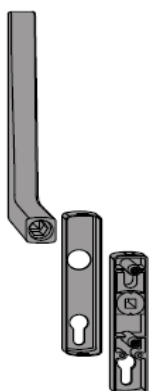

DÉSIGNATION	SIEGENIA-AUBI	UQ
poignée SI-LI.HS300 PZ A. EV2 K1	PMHB0040-526011	1
(Vieux emballage PMHB0040-526010)		

poignée

DÉSIGNATION	SIEGENIA-AUBI	UQ
HEBEL HSK250-PSK200 PZ I. SILBER MATT K1	PMHC0020-5G0011	1
(Vieux emballage PMHC0020-5G0010)		

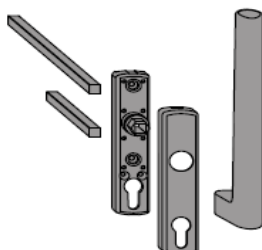

DÉSIGNATION	SIEGENIA-AUBI	UQ
HEBEL HSK250-PSK200 PZ I. F9 K1	PMHC0020-5H4011	1
(Vieux emballage PMHC0020-5H4010)		

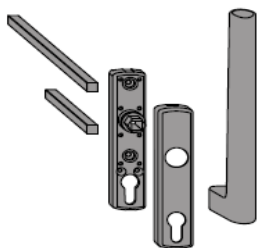

DÉSIGNATION	SIEGENIA-AUBI	UQ
HEBEL SI-LINE HS300 ABNEHMBAR WEISS K1	PHIB0060-502011	1
(Vieux emballage PHIB0060-502010)		

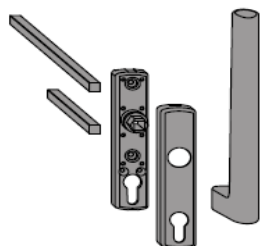

DÉSIGNATION	SIEGENIA-AUBI	UQ
DOUILLE ECROU		
DOUILLE ECROU TS S50/C250	246740 / 800287	250
Fixation d'une poignée d'un seul côté.		

poignée



DÉSIGNATION	SIEGENIA-AUBI	UQ
capuchon Si-line HS 300 RZ, F 9 Aluminium Stahlfarben	PKHB0060-5H4010	1
capuchon Si-line HS 300 RZ, RAL 9005 Tiefschwarz	PKHB0060-523010	1

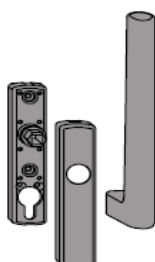

DÉSIGNATION	SIEGENIA-AUBI	UQ
poignée HS300 RZ intérieur, RAL 9005 Tiefschwarz	PMHB0110-523011	1
- poignée HS300 RZ		
- capuchon Si-line HS 300		
poignée HS300 RZ intérieur, unbeschichtet (brut)	PMHB0110-500011	1
- poignée HS300 RZ		
- capuchon Si-line HS 300		

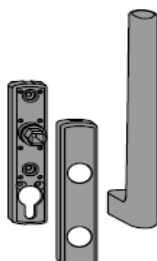

DÉSIGNATION	SIEGENIA-AUBI	UQ
poignée HS300 RZ intérieur, RAL 9005 Tiefschwarz	PMHB0130-523011	1
- poignée HS300 RZ intérieur		
- capuchon Si-line HS 300 RZ		
poignée HS300 RZ intérieur, unbeschichtet (brut)	PMHB0130-500011	1
- poignée HS300 RZ intérieur		
- capuchon Si-line HS 300 RZ		

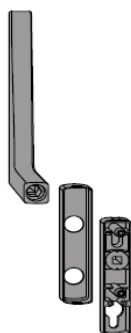

DÉSIGNATION	SIEGENIA-AUBI	UQ
poignée HS300 RZ extérieure, RAL 9005 Tiefschwarz	PMHB0120-523011	1
- poignée HS300 RZ extérieure		
- capuchon Si-line HS 300 RZ		
poignée HS300 RZ extérieure, unbeschichtet (brut)	PMHB0120-500011	1
- poignée HS300 RZ extérieure		
- capuchon Si-line HS 300 RZ		