

## TITAN AF pour bois Si-line 4/18-9

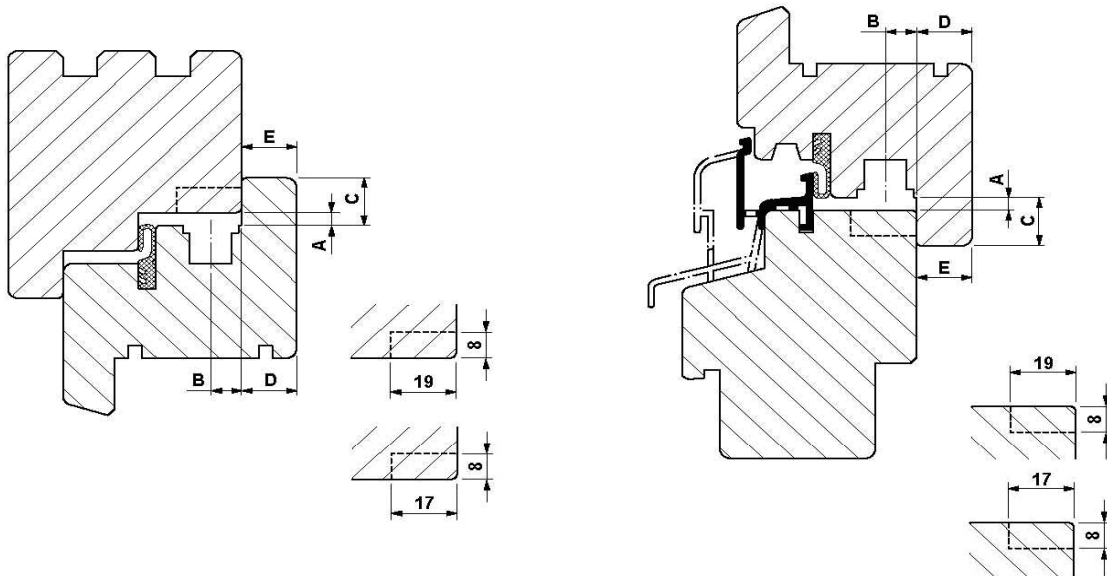

### Information système

<b>A</b>	Jeu feuillure	4,0 <sup>+1</sup>	<b>D</b>	Epaisseur recouvrement	16,0
<b>B</b>	Axe rainure	9,0	<b>E</b>	Hauteur recouvrement	16,0
<b>C</b>	Largeur recouvrement	18,0		Longueur carré poignée	31

Toutes les dimensions sont nominales, indiquées en mm. Elles tiennent compte des tolérances générales.

### Exécutions:

paumelles double trou  
 pièces cadre A0420 Profondeur de fraisage 17mm  
 pièces cadre A0429 Profondeur de fraisage 19 mm

**côté paumelles**

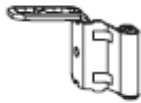

DÉSIGNATION	SIEGENIA-AUBI	UQ
<b>WINKELBAND H-12/18-9 DH A0231 TS K100</b>	TBWB0130-100060	100
avec frein, tourné à 90°		
<b>FICHE COMPAS H-12 /18-9 DH TA C100</b>	TBWB0020-100060	100
avec frein		
<b>WINKELBAND H-12/18-9 O. DH TS K100</b>	TBWB0180-100060	100
sans frein		



DÉSIGNATION	SIEGENIA-AUBI	UQ
<b>Support de compas H-12/18 DH</b>		
avec frein	280034 / 704202	100
sans frein	302156 / 717288	100



DÉSIGNATION	SIEGENIA-AUBI	UQ
<b>Axe pour support de compas D6</b>		
TS	FBSB0010-100060	100

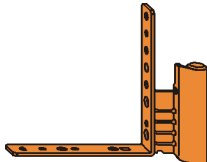

DÉSIGNATION	SIEGENIA-AUBI	UQ
<b>Fiche d'angle Si-line H-4/15 GBA TS</b>		
A0178, droite	275429 / 700259	50
A0178, gauche	275610 / 700372	50

DÉSIGNATION	SIEGENIA-AUBI	UQ
<b>Fiche d'angle Si-line H-4/15 GBA TS (reglage de la pression)</b>		
A0161, droite	304631 / 716397	50
A0161, gauche	304655 / 716403	50



DÉSIGNATION	SIEGENIA-AUBI	UQ
<b>Cale H-4/18-9 A0178</b>		
Dicte 3 mm	/ 876213	1

**côté paumelles**

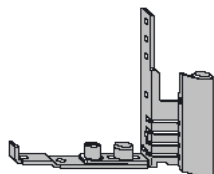

DÉSIGNATION	SIEGENIA-AUBI		UQ
<b>fiche d'angle feuillure H-4/18-9 RE.TS</b>			
rechts	FBFE0011-100010		50
<b>fiche d'angle feuillure H-4/18-9 LI.TS</b>			
links	FBFE0012-100010		50



DÉSIGNATION	SIEGENIA-AUBI		UQ
<b>pièce de distance H-4/18 GENUTET RAL1020</b>			
bei durchgehender Beschlagaufnahme	/	858882	1

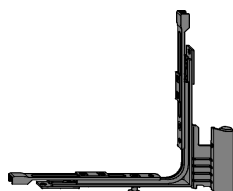

DÉSIGNATION	SIEGENIA-AUBI		UQ
<b>Equerre BSU S-ES H-18-9 TS</b>			
droite	FEUL3021-100040		25
gauche	FEUL3022-100040		25



DÉSIGNATION	SIEGENIA-AUBI		UQ
<b>Pivot Si-line H-12</b>			
max 100 kg	FBEL0010-100060		100



DÉSIGNATION	SIEGENIA-AUBI		UQ
<b>Pivot Si-line H-12</b>			
max 130 kg	275665	/ 700419	250



DÉSIGNATION	SIEGENIA-AUBI		UQ
<b>Axe pour pivot D7</b>			
TS	FBLB0030-100060		100



DÉSIGNATION	SIEGENIA-AUBI		UQ
<b>Pièce de remplissage H-12/18</b>			
pour pivot	275917	/ 700617	500

**côté paumelles**

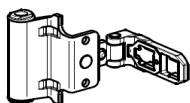

DÉSIGNATION	SIEGENIA-AUBI		UQ
<b>Fenêtres en biais</b>			
FICHE COMPAS SF H-12/18-9 DH TA U1 C100	TBWS0020-100060		100



DÉSIGNATION	SIEGENIA-AUBI		UQ
<b>Fiche d'imposte H-12/18-9</b>			
avec rainure 16 mm	276075	/ 700754	50



DÉSIGNATION	SIEGENIA-AUBI		UQ
<b>Fiche du milieu H-ON 12/18-9</b>			
sans rainure	276112	/ 700792	50



DÉSIGNATION	SIEGENIA-AUBI		UQ
<b>Fiche du milieu H-12/18-9</b>			
avec rainure	276099	/ 700778	50

**plein cintre**

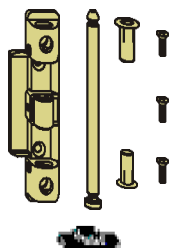

DÉSIGNATION	SIEGENIA-AUBI		UQ
<b>BB 312/CINTRE H-12/18 TA S1/C5</b>			
fenêtre cintrée	275092	/ 700013	5

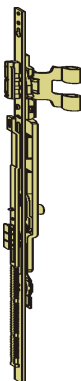

DÉSIGNATION	SIEGENIA-AUBI		UQ
<b>COMPAS PC BOIS 12/18 9 TA C25</b>			
fenêtre cintrée	279915	/ 704097	25

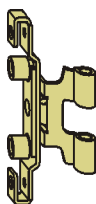

DÉSIGNATION	SIEGENIA-AUBI		UQ
<b>PAUM. OF CINT. H-12/18-9 TA C25</b>			
fenêtre cintrée	FBDF0040-100040		25



DÉSIGNATION	SIEGENIA-AUBI		UQ
<b>Support de compas pour RB/SB H-12/18</b>			
fenêtre cintrée		/ 707197	25



DÉSIGNATION	SIEGENIA-AUBI		UQ
<b>Axe pour support de compas RB</b>			
fenêtre cintrée	280003	/ 704189	500



DÉSIGNATION	SIEGENIA-AUBI		UQ
<b>Douille pour attache de compas</b>			
fenêtre cintrée	229965	/ 836354	50

## gâche A0420, profondeur de fraisage 17mm



DÉSIGNATION	SIEGENIA-AUBI		UQ
<b>Gâche VS</b>			
A0420	302064	/ 717226	500



DÉSIGNATION	SIEGENIA-AUBI		UQ
<b>Gâche 15° pour pivot 3 vant</b>			
A0420	FRSE0020-100010		500



DÉSIGNATION	SIEGENIA-AUBI		UQ
<b>Gâche pour VSU S-ES FH</b>			
A0420, droite	303160	/ 717776	100
A0420, gauche	303184	/ 717783	100



DÉSIGNATION	SIEGENIA-AUBI		UQ
<b>Gâche pour DV 2 vant</b>			
A0420	284667	/ 722275	250



DÉSIGNATION	SIEGENIA-AUBI		UQ
<b>Gâche pour 1 vant F</b>			
A0430, zinguée jaune	FRKS0090-100070		250



DÉSIGNATION	SIEGENIA-AUBI		UQ
<b>SCHLISSBLECH S-RS</b>			
SCHLISSBLECH S-RS A0432 TS K100	TRSK0630-100060		100



DÉSIGNATION	SIEGENIA-AUBI		UQ
<b>Loqueteau</b>			
A0420	302194	/ 717325	100

## gâche A0420, profondeur de fraisage 17mm



DÉSIGNATION	SIEGENIA-AUBI		UQ
Plaque pour loqueteau TS	286432	/ 707982	500
plaque support TS	284520	/ 708064	500



DÉSIGNATION	SIEGENIA-AUBI		UQ
Douille pour loqueteau			
TS	285138	/ 708644	500

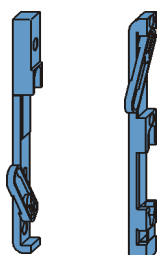

DÉSIGNATION	SIEGENIA-AUBI		UQ
Targette du haut et du bas			
A0420 VSO (haut)	302033	/ 717165	25
A0420 VSU (bas)	302026	/ 717158	25

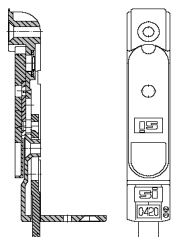

DÉSIGNATION	SIEGENIA-AUBI		UQ
VERROU COURT EX0420			
VERROU COURT EX0420 TA C25	FFKR0030-100040		25

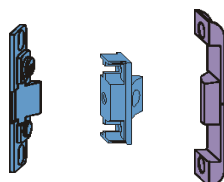

DÉSIGNATION	SIEGENIA-AUBI		UQ
Fiche du milieu invisible			
vantail, sans rainure	275986	/ 700662	100
vantail, avec rainure	275979	/ 700655	100
cadre, A0429 / 17mm	NRZM0010-100010		100



DÉSIGNATION	SIEGENIA-AUBI		UQ
Gâche à trou (emploi avec crémone DSG)			
droite A0434 9 MM / 17 MM TS	NRZA0011-100010		100
gauche A0434 9 MM / 17 MM TS	NRZA0012-100010		100



DÉSIGNATION	SIEGENIA-AUBI		UQ
Gâche à trou (emploi avec crémone DS)			
droite A0436 11 MM / 17 MM TS	NRZA0021-100010		100
gauche A0436 11 MM / 17 MM TS	NRZA0022-100010		100

## gâche A0420, profondeur de fraisage 17mm

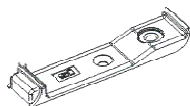

DÉSIGNATION	SIEGENIA-AUBI		UQ
<b>Plaque pour anti-fausse manoeuvre</b>			
A0420	302200	/ 717332	100

DÉSIGNATION	SIEGENIA-AUBI		UQ
<b>Gâche avec appuie pour RB</b>			
A0434 / 17 mm, droite	NRAL0011-100010		1
A0434 / 17 mm, gauche	NRAL0012-100010		1

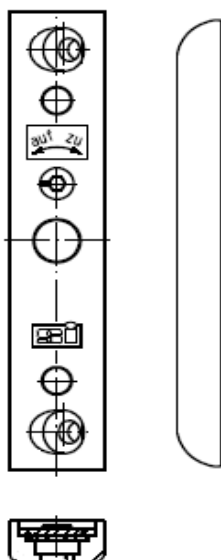

DÉSIGNATION	SIEGENIA-AUBI		UQ
<b>Accessoire pour compas à frein</b>			
A0420, avec tige de renfort	275146	/ 700051	25
Inhalt			
- 2 Stück PASSKERBSTIFT DIN 1472 5X30		844304	
- 1 Stück SCHERENLAGER A0420 TS		722558	

## gâche A0429, profondeur de fraisage 19mm



DÉSIGNATION	SIEGENIA-AUBI	UQ
<b>Gâche VS</b>		
A0429	FRSG0020-100060	100



DÉSIGNATION	SIEGENIA-AUBI	UQ
<b>Gâche 15° pour pivot 3 vant</b>		
A0429	FRSE0050100010	500

Desiné DIN gauche

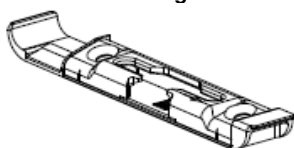

DÉSIGNATION	SIEGENIA-AUBI	UQ
<b>A utiliser avec le nouvel angle 140/210 TITAN AF</b>		
<b>Profondeur de fraisage 19mm</b>		
gache pivot S-ES FH LI A0434 TS K100	TRKA0012-100060	100
gache pivot S-ES FH RE A0434 TS K100	TRKA0011-100060	100

Desiné DIN droite

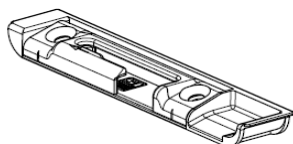

DÉSIGNATION	SIEGENIA-AUBI	UQ
<b>Profondeur de fraisage 19mm</b>		
gache pivot S-ES FH TBT RE A0434 TS K100	TRKB0011-100060	100
gache pivot S-ES FH TBT LI A0434 TS K100	TRKB0012-100060	100

Desiné DIN droite

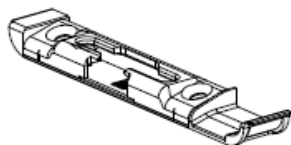

<b>Reste dans l'assortiment pour stulp DS et DSG</b>		
<b>Profondeur de fraisage 19mm</b>		
gache pivot A0434, gauche	289273 / 712887	100
gache pivot A0434, droite	289945 / 712863	100



DÉSIGNATION	SIEGENIA-AUBI	UQ
Gâche pour DV 2 vant A0431	284742 / 708279	250

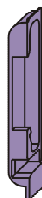

DÉSIGNATION	SIEGENIA-AUBI	UQ
Gâche pour 1 vant F A0431	284940 / 708453	250



DÉSIGNATION	SIEGENIA-AUBI	UQ
gache rouleau S-RS RE. A0429 TS K100 <b>droite</b>	TRSK0621-100060	100
gache rouleau S-RS LI. A0429 TS K100 <b>gauche</b>	TRSK0622-100060	100



DÉSIGNATION	SIEGENIA-AUBI	UQ
<b>Loqueteau</b>		
A0429	284599 / 717325	100

## gâche A0429, profondeur de fraisage 19mm



DÉSIGNATION	SIEGENIA-AUBI		UQ
<b>Plaque pour loqueteau</b>			
TS	286432	/ 707982	500



DÉSIGNATION	SIEGENIA-AUBI		UQ
<b>Douille pour loqueteau</b>			
TS	285138	/ 708644	500

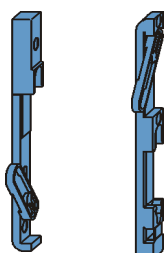

DÉSIGNATION	SIEGENIA-AUBI		UQ
<b>Targette du haut et du bas</b>			
A0434 VSO, droite	275306	/ 700181	25
A0434 VSO, gauche	275450	/ 717158	25
A0434 VSU, droite	275290	/ 700174	25
A0434 VSU, gauche	275313	/ 700280	25

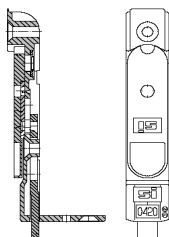

DÉSIGNATION	SIEGENIA-AUBI		UQ
<b>VERROU COURT EX0420</b>			
VERROU COURT EX0420 TA C25	FFKR0030-100040		25

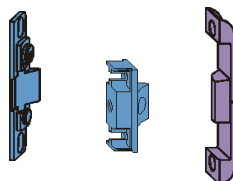

DÉSIGNATION	SIEGENIA-AUBI		UQ
<b>Fiche du milieu invisible</b>			
vantail, sans rainure	275986	/ 700662	100
vantail, avec rainure	275979	/ 700655	100
cadre, A0429	275993	/ 700679	100



DÉSIGNATION	SIEGENIA-AUBI		UQ
<b>Gâche à trou (emploi avec crémone DSG)</b>			
droite A0434 9 MM TS	297049	/ 714645	100
gauche A0434 9 MM TS	297087	/ 714669	100



DÉSIGNATION	SIEGENIA-AUBI		UQ
<b>Gâche à trou (emploi avec crémone DS)</b>			
droite A0436 11 MM TS	297063	/ 714652	100
gauche A0436 11 MM TS	297100	/ 714676	100

## gâche A0429, profondeur de fraisage 19mm

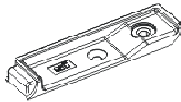
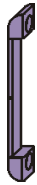

DÉSIGNATION	SIEGENIA-AUBI		UQ
<b>Plaque pour anti-fausse manoeuvre</b>			
A0429	279250	/ 703441	100

DÉSIGNATION	SIEGENIA-AUBI		UQ
<b>Gâche avec appuie pour RB</b>			
A0434, droite		/ 718001	1
A0434, gauche		/ 718018	1

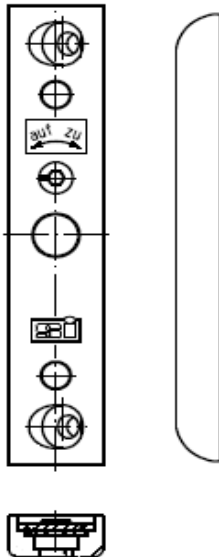

DÉSIGNATION	SIEGENIA-AUBI		UQ
<b>Accessoire pour compas à frein</b>			
A0420, avec tige de renfort	275146	/ 700051	25
Inhalt			
- 2 Stück PASSKERBSTIFT DIN 1472 5X30		844304	
- 1 Stück SCHERENLAGER A0420 TS		722558	

**gabarites**

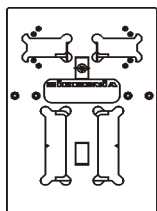

DÉSIGNATION	SIEGENIA-AUBI		UQ
<b>Gabarit de fraisage ST</b>			
pour gâche et compas	139431	/	1

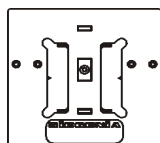

DÉSIGNATION	SIEGENIA-AUBI		UQ
<b>Gabarit de fraisage</b>			
pour gâche dormant	139479	/	1

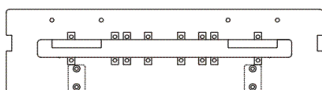

DÉSIGNATION	SIEGENIA-AUBI		UQ
<b>Gabarit de fraisage</b>			
pour gâche S-ES FH et compas RB	157534	/	1

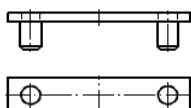

DÉSIGNATION	SIEGENIA-AUBI		UQ
<b>Plaque de distance</b>			
pour gabarit S-ES	138922	/	1



DÉSIGNATION	SIEGENIA-AUBI		UQ
<b>Serrage rapide</b>			
court		/ 829660	1
long		/ 829677	1

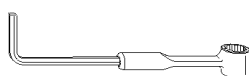

DÉSIGNATION	SIEGENIA-AUBI		UQ
<b>Clé de réglage</b>			
SW4 / SW11	157756	/	1

**gabarites**

DÉSIGNATION	SIEGENIA-AUBI		UQ
<b>Gabarit de fraisage</b>			
KRL 1flg E99465 Frässchablone 27/16			
Für Kippriegellager S-ES TRKA.....	E99465		1
In Kombination mit Umlenkung 140/210			

